

hidrotren
Sistemas y Tecnología del agua / Water System Technology



FAMILIA 01/02/10
FAMILY

ACCESORIOS PRESIÓN PVC-U

U-PVC PRESSURE FITTINGS

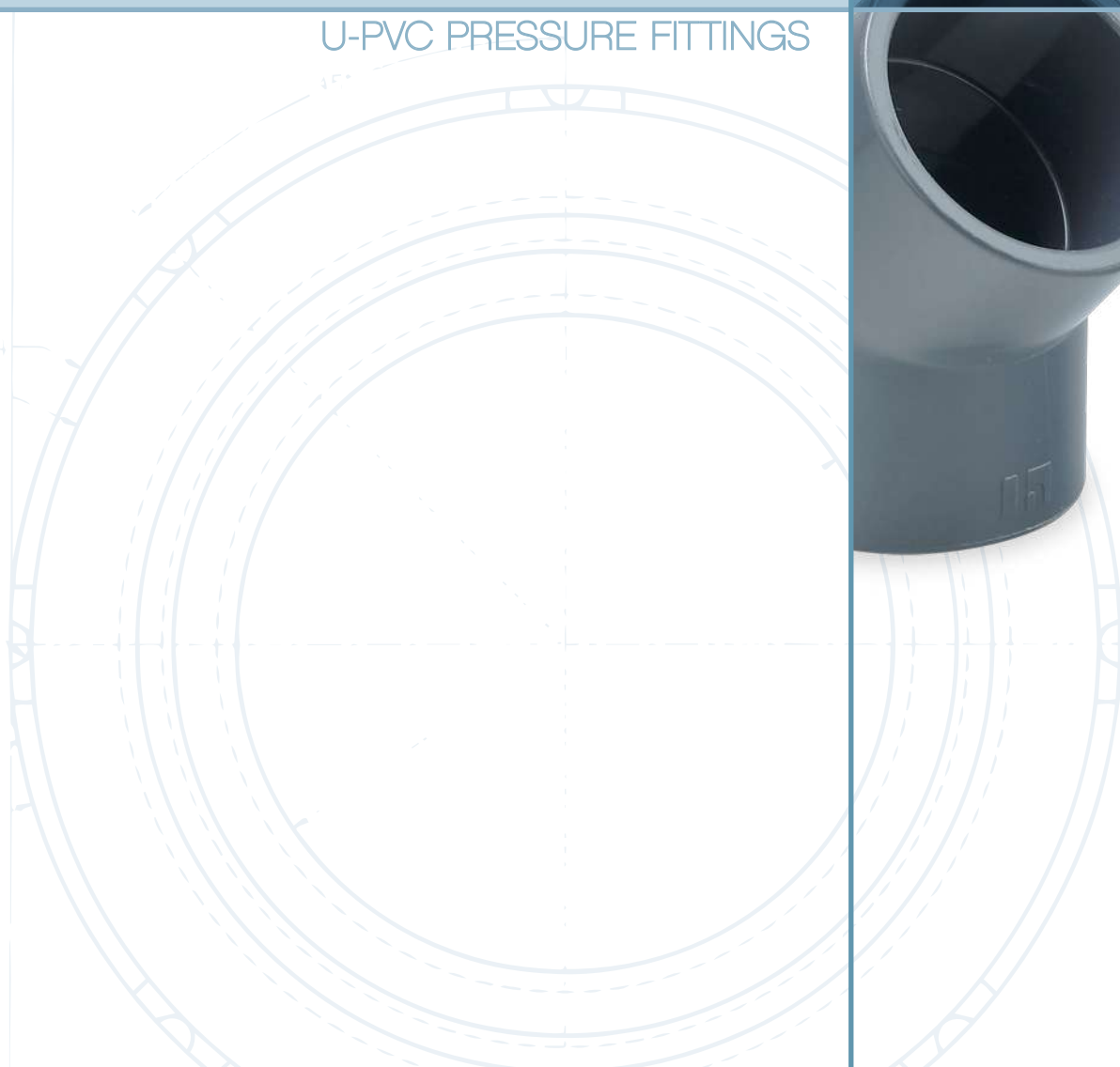



PVC-U con certificación WRAS

El PVC-U utilizado por Hidroten en todos sus accesorios está certificado por WRAS (Water regulation advisory Scheme), organismo que valida la aptitud de los materiales para su uso en aplicaciones de agua potable. Esta certificación es garantía de la máxima calidad del PVC-U utilizado por Hidroten.

The PVC-U used by Hidroten in all our fittings is certified by WRAS (Water regulation advisory Scheme), a organization that certifies the suitability of materials for being used in drinking water applications. This certification is warranty of the maximum quality of the PVC-U used by Hidroten.

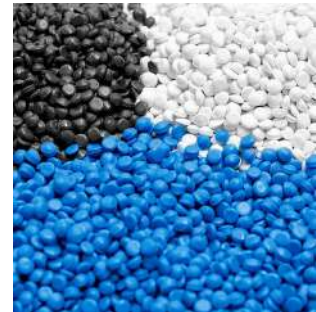

Uniones encolar según UNE-EN 1452

En todas las instalaciones, es imprescindible la compatibilidad entre tubo y accesorios, para ello se desarrollaron múltiples normativas. Los accesorios de PVC-U de Hidroten se rigen por la normativa Europea UNE-EN 1452, la cual regula las características y dimensiones tanto de la tubería como de los accesorios.

In all the installations, compatibility among the tube and the accessories is essential, and for that reason, many standards are developed. Hidroten's PVC-U accessories are ruled by the European norm UNE-EN 1452, which establishes the characteristics and size of the pipe and the accessories.



Uniones roscadas según UNE-EN 19009

Las uniones roscadas de los accesorios de presión de PVC-U fabricadas por Hidroten, al igual que ocurre con los accesorios encolar, se rigen por otra normativa estándar europea, la norma UNE-EN 19009.

The threaded connections of the PVC-U pressure accessories made by Hidroten, as well as the solvent socket accessories, are ruled by another standard European norm, the UNE-EN 19009.



CERTIFICACIONES / CERTIFICATIONS

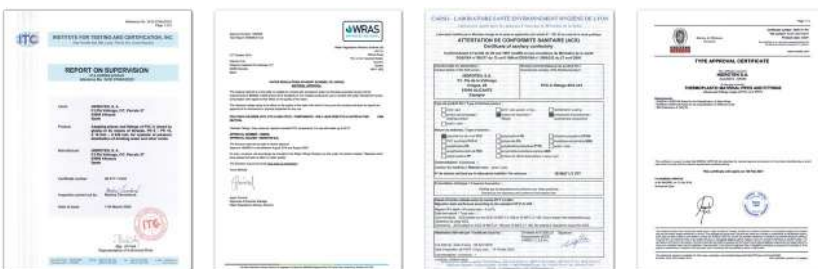

SECTOR	Agricultura, piscina, obras públicas e industria / <i>Agriculture, swimming pool, civil engineering and industry</i>
MATERIAL	PVC-U / <i>PVC-U</i>
MARCAJE / MARKING	Marcas de montaje indicadoras de posición / <i>Installing marks for indicating position</i>
MEDIDAS / MEASURES	<i>Encolar / Solvent socket: Desde Ø16 a 400 / From Ø16 to 400</i> <i>Roscar y mixtos / Thread and mixed: Desde Ø1/8" a 4" / From Ø1/8" to 4"</i> <i>Junta elástica / Rubber ring: Desde Ø63 a 200 / From Ø63 to 200</i>
PN	<i>Encolar / Solvent socket</i> PN 16 desde Ø16 a 140 / <i>PN 16 from Ø16 to 140</i> PN 10 desde Ø160 a 315 / <i>PN 10 from Ø160 to 315</i> PN 6 Ø400 / <i>PN 6 Ø400</i> <i>Roscar y mixtos / Thread and mixed: PN 10 desde Ø1/8" a 4" / PN 10 from Ø1/8" to 4"</i> <i>Junta elástica / Rubber ring union: PN 10 desde Ø63 a 200 / PN 10 from Ø63 to 200</i>

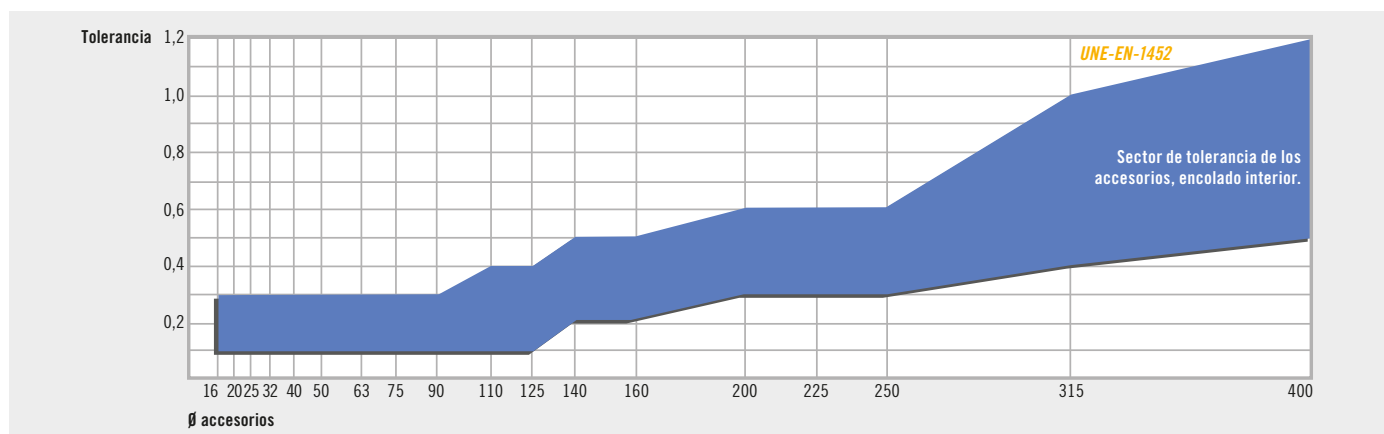

Resultados ensayos según UNE -EN 1452 / Results tests according to standard UNE-EN 1452

Propiedad / Property	Requisitos según norma / Requirements as standard	Valor medio obtenido / Mean value obtained	I (K=2)	Resultado / Result
Densidad / Density	Entre 1.350 y 1.460 Kg/m ³ . <i>Between 1.350 and 1.460 Kg/m³.</i>	1.383	+ -1	Cumple / OK
Temp. Vicat / Vicat temp.	>74°C	77	+ -1	Cumple / OK
Comportamiento al calor / Heat behaviour	No presentar burbujas o separación de líneas de soldadura. <i>Do not produce bubbles or separation of the welding lines.</i>			Cumple / OK
Absorción de agua / Water absorption	>50 g/m ²	22	-	Cumple / OK
Aspecto / Appearance	Superficie lisa y distribución uniforme del color. <i>Flat surface and uniform colour distribution.</i>			Cumple / OK
Resistencia a la presión / Pressure resistance	20°C / 60°C	Ensayo superado / <i>Ensayo superado.</i> <i>Passed test / Passed test.</i>		Cumple / OK

CONSEJOS DE ENCOLADURA / HANDLING TIPS



Cortar el tubo perpendicular
Cut the pipe perpendicular



Biselar el tubo
Bevelling the pipe



Limpiar tubo con disolvente
Clean pipe with solvent



Aplicar cola en tubo y accesorio
Apply glue to pipe and fitting



Alinear con los marcajes
Aligned with the markings

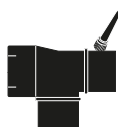

Limpiar la parte macho con disolvente
Clean male part with solvent



Aplicar cola en accesorios macho y hembra
Apply glue to male and female fittings



Alinear con los marcajes
Aligned with the markings

La inclusión de accesorios con sistema **Slide System**, con **unión mediante junta elástica**, amplía y complementa la extensa gama de accesorios PVC de Hidroten.

Los accesorios con sistema Slide facilitan un **montaje más rápido** gracias a su junta elástica y ofrecen las mismas garantías que los accesorios de PVC de Hidroten, añadiendo las ventajas de una puesta en carga más rápida y de la posibilidad de reutilización.

The inclusion of the **Slide System fittings with elastic gasket union**, enlarges and complements the wide range of PVC fittings of Hidroten.

The Slide System fittings provide a **quicker assembly** due to its elastic gasket, offering the same warranty that the rest of PVC fittings of Hidroten, adding the advantages of a faster loading start and the possibility of reusing the fittings.

RECOMENDACIONES DE MONTAJE SISTEMA SLIDE / RECOMMENDATION SLIDE SYSTEM ASSEMBLY



1. Colocar la abrazadera de fijación en el tubo. / Install the fixation clamp in the pipe.

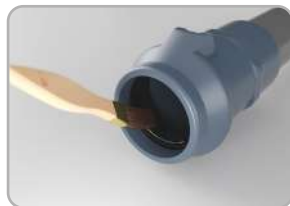

2. Lubricar la junta, con ello conseguiremos un montaje más sencillo y evitaremos dañar la junta. / Lubricate the gasket for easy assembly and avoid damages.



3. Presentar e introducir el tubo con cuidado para no pellizcar la junta. / Introduce carefully the pipe for avoiding damages in the gasket.



4. Llegar con el tubo hasta el tope y colocar el gancho en el alojamiento de manguito Slide. / Arrive to the pipe limit and fit fixation clamp in the Slide adaptor.



5. La abrazadera de fijación nos aporta resistencia a los esfuerzos. / The fixation clamp give resistance against axial stress.

El SISTEMA SLIDE es un sistema de montaje rápido, basado en una junta perimetral que garantiza una perfecta estanqueidad y facilita la instalación, aportando una agilidad superior a los accesorios de PVC convencionales.

The SLIDE SYSTEM is a fast assembling system, based on a perimeter joint which ensures perfect water tightness and makes installation easier, providing a higher agility to conventional PVC accessories.



Hidroten desarrolla una gama innovadora de productos, la línea **DUAL SYSTEM**, accesorios con cuerpo de PVC que integran conexiones con nuestro sistema único de fitting. Una serie ideada para realizar **transiciones directas** entre conducciones de **PE y PVC**, con una integración total. La gama está completamente realizada en PN16 y está compuesta por *te reducida, cruz reducida y enlace de transición*.

El concepto **DUAL SYSTEM** **minimiza el número de accesorios**, eliminando uniones, lo que aporta mayor seguridad y agilidad en el montaje de las instalaciones, y conlleva importantes ahorros.

Hidroten has developed a innovative range of products, the **DUAL SYSTEM** line, fittings with PVC body that have integrated connections with our unique compression fitting system. The series has been designed for making **directs transitions between PE and PVC** pipes, with total integration. The range is completely PN16 and is composed by reducing tee, reducing cross and transition union.

The **DUAL SYSTEM** concept **minimizes the number of fittings**, avoiding unions, what provides more security and agility in the assembly of the installations, what implies important savings.



Hidroten, con el Sistema NOTUB y la Serie "AIR", aporta a los profesionales del sector una serie de productos funcionales que los hacen únicos en el mercado. Estos productos, gracias al I+D+I logran diferenciarse gracias a su funcionalidad, seguridad y operatividad, tratando de responder a las necesidades del mercado.

Hidroten, with its NOTUB system and "AIR" series, brings to the professionals of the sector a series of functional products which make them unique on the market. The R&D department brings differentiation to these products with more functionality, security and effectiveness, with the aim of responding to market needs.

SERIE "AIR"



Hidroten, en su afán innovador, ofrece al mercado una serie de accesorios que poseen un elemento diferenciador, que es la incorporación de una salida roscada o encolada en la configuración del accesorio.

Hidroten, in the aim of constantly bringing innovation, offers to the market a series of fittings with one differential element, the incorporation of a threaded or solvent socket outlet in the fitting configuration.

■ La serie "AIR" se caracteriza por la novedad de sus **salidas roscadas directas**, gracias a las cuales evitaremos tener que realizar perforaciones en la pieza o en la tubería, de manera que obtendremos las siguientes ventajas:

- **Mayor seguridad**, ya que evitaremos posibles roturas.
- **Menor mano de obra** y tiempo de instalación.
- **Mejora notable en el diseño** de nuestras instalaciones.

■ The "AIR" series is notable for its **direct threaded outlets**, avoiding drills in either the part or the pipe, bringing following advantages:

- **Better security**, since we'll avoid possible break downs.
- **Reducing labour** and installation cost.
- **Notable improvement** of the installations design.



Hidroten cuenta en su amplia gama de accesorios de presión, con la gama de Sistema Notub. Estos productos se caracterizan por poseer salidas encolar macho y encolar hembra, aportando mayor polivalencia.

Hidroten innovates by widening its range of pressure fittings, with the incorporation of the Notub System fitting series. These fittings are notable for their male solvent socket and Female solvent socket outlets, bringing more versatility.

■ El sistema **NOTUB permite la unión directa entre accesorios y valvulería**. Al igual que el resto de accesorios de presión, el sistema **NOTUB** ofrece siempre las máximas prestaciones y garantías de calidad. Esto permite:

- **Ahorro considerable en número de encoladuras**.
- **Ahorro de espacio** al tener instalaciones más compactas.
- **Ahorro en tiempo de instalación**.

■ **NOTUB system allows direct union between fittings and valves**. As the rest of pressure fittings, NOTUB system always offers maximum services and quality guarantees. It brings:

- **Considerable saving of collages numbers**.
- **Space saving**, since installations are more compact.
- **Installation time saving**.





Bridas en PVC-U, PPFV y PA

La familia de bridas y portabridas de Hidroten, están fabricadas en PVC-U, PPFV y PA. Éstas se caracterizan por sus curvaturas especiales, que eliminan los puntos de aristas, así como por su mayor espesor y nervaduras estructuradas.

The family of Hidroten flanges and flange adaptors are made of PVC-U, GFPP and PA. They are characterized by their special bends which eliminate the edges' points, as well as by a higher thickness and structured ribbing.



Bridas DIN 2576, ANSI 16,5, BS 10 tabla, UNE-EN 1452

Las bridas de Hidroten han sido diseñadas para adaptarse a todas las normativas internacionales para bridas. Siempre, a la hora de elegir la más adecuada deberá consultar la distancia entre tornillos para conocer la compatibilidad.

Hidroten flanges have been designed to be adapted to all the international standards for flanges. Always, when choosing the most appropriate one, you should consult the distance between screws to know the compatibility.



Sistemas cónicos y cónico seguridad

El diseño con asientos cónicos entre brida y portabrida, ofrecen mayor superficie de apoyo entre ambos. Las bridas cónicas presentan refuerzos triangulares, teniendo un espesor superior y ofreciendo una mayor resistencia y seguridad frente a roturas por apriete.

The design with conical seats between the flange and the flange holder, offers more support surface between both. The conical flanges have triangular reinforcements, with a higher thickness and offer greater resistance and safety against breakings due to tightening.



SISTEMA
CÓNICO

UNICO
mercado

CERTIFICACIONES / CERTIFICATIONS



SECTOR	Agricultura, piscina, obras públicas e industria / <i>Agriculture, swimming pool, civil engineering and industry</i>
MATERIAL	PVC-U, PPFV o PA / <i>PVC-U, GFPP or PA</i>
MARCAJE / MARKING	Medida y numeración en agujeros de las bridas de orden de apriete de tornillos para evitar tensiones / <i>Size and bolts tightening order for avoiding excess of tension</i>
MEDIDAS / MEASURES	Salida encolar, desde Ø50 a 400 / <i>Solvent socket outlet from Ø50 to 400</i> Salida PE, desde Ø50 a 315 / <i>PE outlet from Ø50 to 315</i> Salida roscar, desde 1 1/2" a 4" / <i>Female threaded outlet from 1 1/2" to 4"</i> Sistema cónico, desde Ø90 a 160 / <i>Conical system from Ø90 to 160</i>
PN	PN 16 Ø50 - Ø140; PN10 Ø160 - Ø315; PN 6 Ø400. PN 10 para bridas roscadas / <i>for threaded flanges</i>

DESPIECE / QUARTERING

MODELO CÓNICO



1. Ángulos romos
2. Pasadores reforzados para tornillería
3. Nervaduras perimetrales de seguridad
4. Desarrollo dimensional para potenciar su seguridad
5. Perfecta unión mediante asientos cónicos
6. Asiento estanqueidad, junta plana

Brida fabricada mediante inyección directa

1. Blunt corners
2. Pins reinforced for screws
3. Perimeter security ribs
4. Dimensional development to enhance safety
5. Perfect union with conical seats
6. Seat sealing gasket

Built with direct injection

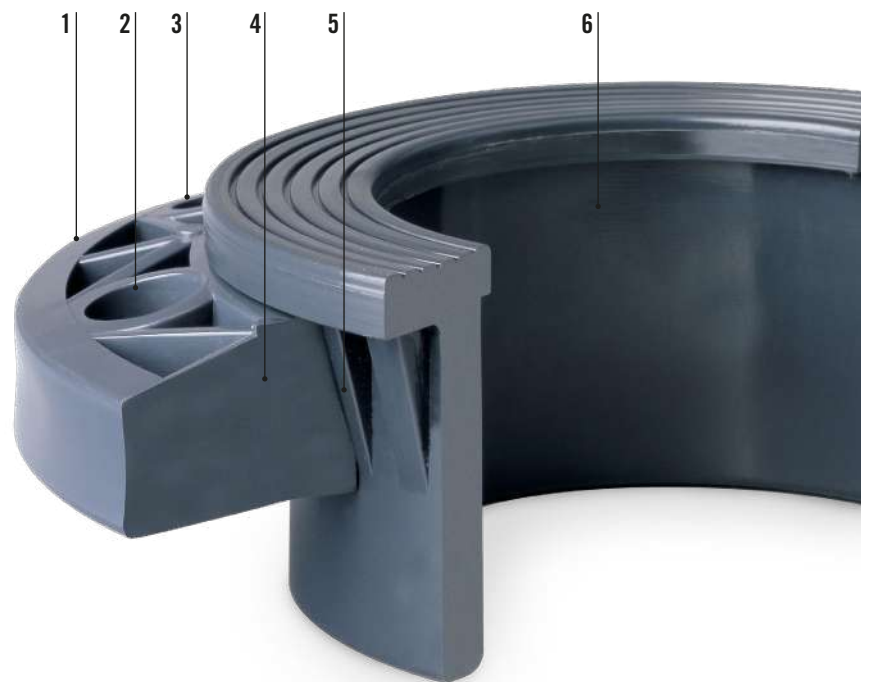

APRIETE BRIDAS / TIGHTENS FLANGES

A la hora de montar una brida, se tendrá en cuenta el orden secuencial de apriete tal como indican las grabaciones de las bridas; esta secuencia siempre será en cruz, es decir, una vez montado un tornillo, el siguiente a acoplar será el opuesto.

When mounting flange, will take into account the sequential order as indicated clamping flange recordings; this sequence will always be in a cross, that is, once mounted a screw, the following will be the opposite coupling.

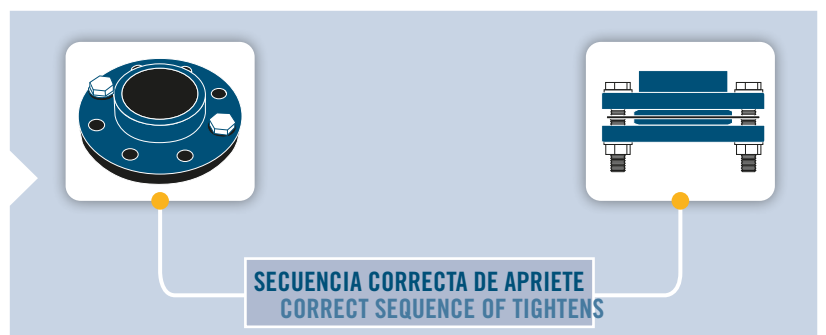
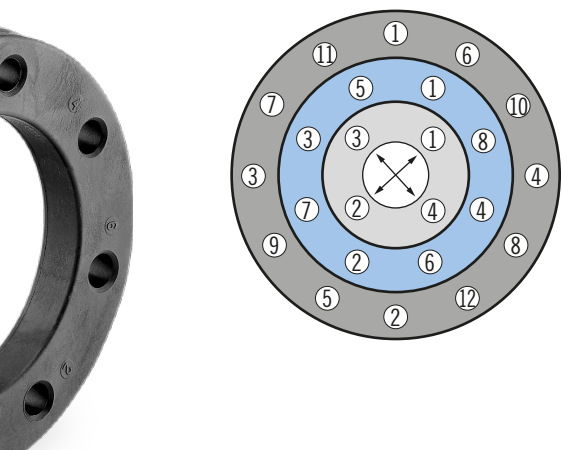



SlideSystem

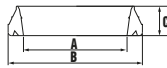

06S

Junta elástica
Rubber ring gasket
Joint élastique

CÓDIGO / CODE	∅	PESO / WT (g.)	A	B	C
98875	63	25	64	84	19
98876	75	38	76	98	20
98877	90	54	92	116	21
98878	110	78	113	139	23
98879	125	97	126	156	25
98880	140	123	144	172	25
98881	160	160	165	195	27
98882	200	242	206	238	30



SlideSystem

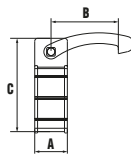

07S

Abrazadera fijación
Fixation clamp
Anneau de fixation

CÓDIGO / CODE	∅	PESO / WT (g.)	A	B	C
01811	63	170	34	49	70



SlideSystem
NOTUB

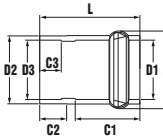

01S

Manguito junta elástica PVC
PVC adaptor coupling rubber ring-solvent socket
Manchon joint élastique PVC

CÓDIGO / CODE	∅ D1-D2-D3	DN	PESO / WT (g.)	B	C1	C2	C3	L
01815	63-63-50	50-40	288	92	100	38	31	146
01816	63-75-63	50	304	92	100	44	38	148



SlideSystem

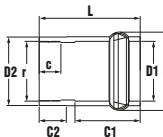

02S

Manguito junta elástica R/Hembra
PVC adaptor coupling rubber ring-female thread
Manchon joint élastique taraudée

CÓDIGO / CODE	∅ D1-D2-r	DN	PESO / WT (g.)	B	C1	C2	c	L
02530	63-63-1 1/2"	50-40	327	92	100	38	31	146
02531	63-75-2"	50	349	92	100	44	38	148



SlideSystem

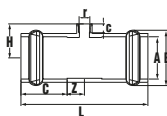

03S

Te junta elástica reducida R/H
Rubber ring reducing tee-female thread
Té joint élastique de réduction taraudée

CÓDIGO / CODE	∅ A-r	DN	PESO / WT (g.)	B	C	c	H	Z	L
02516	63-3/4"	50-20	585	92	100	19	65	35	270
02517	75-3/4"	65-20	895	109	104	19	72	40	288
02518	90-3/4"	80-20	1.475	127	109	19	78	50	318
02520	63-1"	50-25	580	92	100	21	65	35	270
02521	75-1"	65-25	890	109	104	21	72	40	288
02522	90-1"	80-25	1.470	127	109	21	78	50	318

Refuerzo en acero inoxidable A-2 / Stainless steel reinforcement A-2.



Slide System
NGTUB

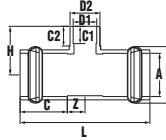

Te junta elástica encolar
Rubber ring tee-solvent socket
Té joint élastique à coller

04S

CÓDIGO / CODE	∅ A-D1-D2	DN	PESO / WT (g.)	B	C	C1	C2	H	Z	L
01825	63-50-63	50-40	630	92	100	31	38	84	35	270
01826	75-63-75	65-50	940	109	104	38	44	96	40	288
01827	90-75-90	80-65	1.580	127	109	44	51	116	50	318



Slide System

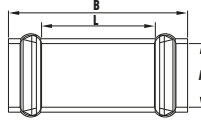

Manguito reparación junta elástica
PVC rubber ring repairing coupling
Manchon PVC avec joint élastique

05S

CÓDIGO / CODE	∅ A	DN	PESO / WT (g.)	B	L
01790	63	50	435	274	210
01791	75	65	625	300	232
01792	90	80	805	330	258
01793	110	100	1.265	370	290
01794	125	110	1.680	400	316
01795	140	125	2.475	450	362
01796	160	150	3.190	462	366
01797	200	175	4.950	550	442

Manguito sin topes interiores / Sleeve without internal stoppers.



BLANCA

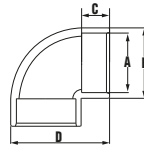

Codo 90° encolar
90° elbow
Coude 90°

01/31

CÓDIGO / CODE	CÓDIGO / CODE	∅ A	DN	PESO / WT (g.)	B	C	D
01140	01350	16	10	11,4	22	15	35
01074	01351	20	15	15	27	16	41
01001	-	25	20	30	33	19	50
01002	-	32	25	53	41	22	61
01003	-	40	32	92	50	26	74
01004	01355	50	40	136	61	31	88
01005	01356	63	50	257	76	38	109
01006	-	75	65	413	90	44	130
01007	-	90	80	690	108	51	151
01008	-	110	100	1.244	131	61	184
01009	-	125	110	1.526	143	69	210
01010	-	140	125	2.410	164	76	234
01011	-	160	150	2.854	182	86	265
01146	-	180	165	6.780	225	106	320
01012	-	200	175	4.476	225	106	320
01091	-	225	200	9.633	252	119	362
01092	-	250	225	12.248	284	131	452
01093	-	315	300	23.750	352	164	583
01301	-	400	325	35.960	442	206	727



BLANCA

Slide System
NGTUB
ÚNICO en el mercado

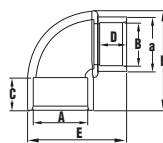

Codo 90° encolar H/M
90° reducing elbow
Coude réducteur 90°

02/32

CÓDIGO / CODE	CÓDIGO	∅ A-a-B	DN	PESO / WT (g.)	C	D	E	F
01603	01363	32x32x25	25-20	48	22	19	59	56
01604	-	40x40x32	32-25	87	26	22	89	65
01605	01365	50x50x40	40-32	31	26	85	102	85
01606	01366	63x63x50	50-42	38	31	109	122	109
01607	-	75x75x63	65-50	415	45	38	145	123
01609	-	110x110x90	65-50	1.162	61	51	179	198



03/33/197

Codo 90° encolar R/M
90° elbow plain/male threaded
Coude 90° à coller/fileté

CÓDIGO / CODE	CÓDIGO / CODE	CÓDIGO / CODE*	∅ A-a	DN	PESO / WT (g.)	C	D	E	F
02603	02633	02142	32-1"	25	44-49*	56	22	19	59
02604	-	02143	40-1 1/4"	32	71-77*	75	26	21	74
02605	02635	02144	50-1 1/2"	40	109-120*	91	31	22	85
02606	02636	02145	63-2"	50	245-258*	109	38	26	109

*Con junta tórica/ With o-ring



544

Curva 90° encolar
90° bend
Courbe 90°

CÓDIGO / CODE	∅ A	DN	PESO / WT (g.)	B	C	D
01700	20	15	28	27	16	70
01701	25	20	54	33	19	86
01702	32	25	97	41	22	107
01703	40	32	172	50	26	131
01704	50	40	295	61	31	162
01705	63	50	515	76	38	202
01706	75	65	1.032	90	44	239
01707	90	80	1.813	113	51	261
01708	110	100	2.881	132	61	288



04/34/433

Codo 90° encolar R/H
90° elbow plain/F. threaded
Coude 90° à coller/taraudé

CÓDIGO / CODE	CÓDIGO / CODE	CÓDIGO / CODE*	∅ A-a	DN	PESO / WT (g.)	B	C	D	E
02201	-	02160	20-1/2"	15	21-32*	27	16	41	16
02202	-	02161	25-3/4"	20	34-45*	33	19	50	17
02203	-	02162	32-1"	25	66-79*	41	22	61	21
02204	-	02163	40-1 1/4"	32	120-134*	50	26	74	23
02205	02645	02164	50-1 1/2"	40	145-163*	61	31	88	24
02206	02646	02165	63-2"	50	275-296*	75	38	109	28
02260	-	02061	75-1 1/2"	65-40	589-614*	89	44	129	24
02261	-	02062	75-2"	65-50	562-589*	89	44	129	28
02207	-	02166	75-2 1/2"	65	427-452*	89	44	129	32
02262	-	02063	90-2"	80-50	1.040-1.070*	108	51	156	28
02263	-	02064	90-2 1/2"	80-65	995-1.025*	108	51	156	32
02208	-	02167	90-3"	80	831-861*	108	51	156	35

*Refuerzo en acero inoxidable A-2 / Stainless steel reinforcement A-2.



05/35

Codo 90° rosca H/H
90° elbow F. threaded/ F. threaded
Coude 90° taraudé/taraudé

CÓDIGO / CODE	CÓDIGO / CODE	∅ A	DN	PESO / WT (g.)	B	C	D
02301	-	1/2"	15	22	27	16	41
02302	-	3/4"	20	34	33	17	50
02303	-	1"	25	66	41	21	61
02304	-	1 1/4"	32	97	50	23	74
02305	02675	1 1/2"	40	165	61	24	88
02306	02676	2"	50	322	76	28	109
02307	-	2 1/2"	65	441	89	32	128
02308	-	3"	80	864	107	35	155

623/627

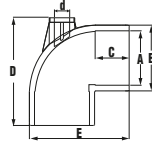

Codo 90° encolar "AIR" s/enc.
"AIR" 90° elbow s. socket outlet
Coude 90° "AIR" sortie f. á collar

CÓDIGO / CODE	CÓDIGO / CODE	Ø A	DN	PESO / WT (g.)	d	B	C	D	E
01630	01480	50	40	145	20	61	31	100	88
01627	01482	50	40	142	25	61	31	100	88
01631	01481	63	50	230	20	76	38	120	109
01628	01483	63	50	226	25	76	38	120	109
01632	-	75	65	450	20	90	44	140	130
01629	-	75	65	445	25	90	44	140	130
01633	-	90	80	806	25	108	51	175	151
01635	-	110	100	1.255	32	131	61	206	184
01636	-	125	110	1.635	32	143	69	234	210
01637	-	125	110	1.602	63	143	69	234	210
01639	-	160	150	2.414	63	182	86	297	265
01640	-	200	175	4.891	63	225	106	340	320

624/628

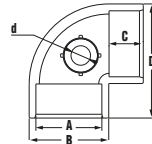

Codo 90° encolar "AIR L" s/enc.
"AIR L" 90° elbow s. socket outlet
Coude 90° "AIR L" fem. á collar

CÓDIGO / CODE	CÓDIGO / CODE	Ø A	DN	PESO / WT (g.)	d	B	C	D
01650	01490	50	40	148	20	61	31	88
01651	01491	63	50	235	20	76	38	109
01652	-	75	65	455	20	90	44	130

429/284

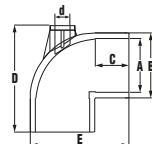

Codo 90° encolar "AIR" R/H
"AIR" 90° elbow female threaded outlet
Coude 90° "AIR" á collar

CÓDIGO / CODE	CÓDIGO / CODE	Ø A	DN	PESO / WT (g.)	d	B	C	D	E
01256	01474	50	40	148	1/2"	61	31	100	88
01590	01476	50	40	146	3/4"	61	31	100	88
01257	01475	63	50	235	1/2"	76	38	120	109
01591	01477	63	50	233	3/4"	76	38	120	109
01258	-	75	65	455	1/2"	90	44	140	130
01592	-	75	65	452	3/4"	90	44	140	130
01259	-	90	80	812	3/4"	108	51	175	151
01260	-	90	100	840	1"	108	51	178	151
01261	-	110	100	1.278	1"	131	61	206	184
01262	-	125	110	1.645	1"	143	63	234	210
01263	-	125	110	1.628	2"	143	69	234	210
01267	-	160	150	2.443	2"	182	86	297	265
01268	-	200	175	4.920	2"	225	106	340	320
01593	-	250	225	9.830	2"	284	131	430	399
01594	-	250	225	9.735	3"	284	131	430	399

758

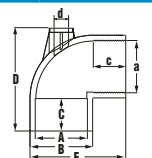

Codo 90° encolar R/H "AIR" salida R/H
"AIR" 90° elbow plain f/t-f/t outlet
Coude 90° "AIR" sortie f. á collar

CÓDIGO / CODE	Ø A-a	DN	PESO / WT (g.)	d	B	C	c	D	E
02270	50-1 1/2"	40	151	1/2"	61	31	24	100	88
02271	50-1 1/2"	40	149	3/4"	61	31	24	100	88
02273	63-2"	50	240	1/2"	76	38	28	120	109
02274	63-2"	50	238	3/4"	76	38	28	120	109

Reforzamiento en acero inoxidable A-2 / Stainless steel reinforcement A-2.
* Boca roscada / Threaded outlet.



759

(*)

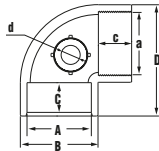

Codo 90° encolar R/H "AIR L" salida R/H
"AIR L" 90° elbow s. socket outlet
Coude 90° "AIR L" sortie f. á coller

CÓDIGO / CODE	∅ A-a	DN	PESO / WT (g.)	d	B	C	c	D
02280	50-1 1/2"	40	148	1/2"	61	31	24	88
02281	50-1 1/2"	40	148	3/4"	61	31	24	88
02283	63-2"	50	235	1/2"	76	38	28	109
02284	63-2"	50	235	3/4"	76	38	28	109

Refuerzo en acero inoxidable A-2 / Stainless steel reinforcement A-2.

* Boca roscada / Threaded outlet.



206/450

BLANCA

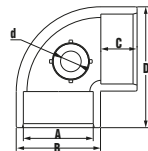

Codo 90° encolar "AIR L" salida R/H
"AIR L" 90° elbow S. socket outlet
Coude 90° á coller "AIR L"

CÓDIGO / CODE	CÓDIGO / CODE	∅ A	DN	PESO / WT (g.)	d	B	C	D
01615	01484	50	40	148	1/2"	61	31	88
01613	-	50	40	152	3/4"	61	31	88
01616	01485	63	50	235	1/2"	76	38	109
01614	-	63	50	282	3/4"	76	38	109
01617	-	75	65	455	1/2"	90	44	130
01619	-	90	80	815	3/4"	108	51	151
01623	-	110	100	1.265	1"	143	61	184

Refuerzo en acero inoxidable A-2 / Stainless steel reinforcement A-2.



06/36

BLANCA

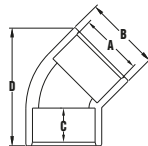

Codo 45° encolar
45° elbow
Coude 45°

CÓDIGO / CODE	CÓDIGO / CODE	∅ A	DN	PESO / WT (g.)	B	C	D
01141	01370	16	10	10	22	15	41
01073	01371	20	15	18	27	16	48
01013	-	25	20	26	33	19	53
01014	-	32	25	43	41	22	63
01015	-	40	32	71	50	26	80
01016	01375	50	40	113	61	31	94
01017	01376	63	50	225	76	38	125
01018	-	75	65	333	90	44	138
01019	-	90	80	604	108	51	168
01020	-	110	100	892	131	61	190
01021	-	125	110	1.123	148	69	215
01022	-	140	125	2.097	164	76	260
01023	-	160	150	2.192	180	86	286
01148	-	180	165	5.725	225	106	346
01024	-	200	175	3.862	225	106	346
01088	-	225	200	5.724	252	119	386
01089	-	250	225	7.715	284	131	435
01090	-	315	300	14.480	352	164	525
01302	-	400	325	23.140	447	206	676

434

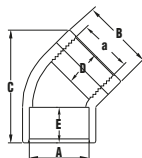

Codo 45° enc. R/H reforzado
45° elbow plain/F. threaded reinforced
Coude 45° à collar/tarudé

CÓDIGO / CODE	∅ A-a	DN	PESO / WT (g.)	B	C	D	E
02170	20- 1/2"	15	28	27	48	16	16
02171	25- 3/4"	20	39	33	53	19	17
02172	32- 1"	25	65	41	63	22	21
02173	40- 1 1/4"	32	89	50	80	26	23
02174	50- 1 1/2"	40	149	61	95	31	31
02175	63-2"	50	259	75	125	38	38
02176	75- 2 1/2"	65	393	89	140	45	44
02177	90- 3"	80	683	107	162	51	51

Refuerzo en acero inoxidable A-2 / Stainless steel reinforcement A-2.

07/37

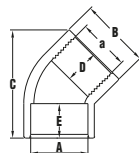

Codo 45° encolar R/H
45° elbow plain/F. threaded
Coude 45° à collar/tarudé

CÓDIGO / CODE	CÓDIGO / CODE	∅ A-a	DN	PESO / WT (g.)	B	C	D	E
02211	-	20-1/2"	15	17	27	48	16	16
02212	-	25-3/4"	20	28	33	53	19	17
02213	-	32-1"	25	52	41	63	22	21
02214	-	40-1 1/4"	32	74	50	80	26	23
02215	02655	50-1 1/2"	40	131	61	95	31	24
02216	02656	63-2"	50	234	75	125	38	28
02217	-	75-2 1/2"	65	358	89	140	45	32
02218	-	90-3"	80	638	107	162	51	35

198

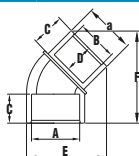

Codo 45° encolar H/M
45° elbow plain/F. threaded
Coude 45° à collar/tarudé

CÓDIGO / CODE	∅ A-a-B	DN	PESO / WT (g.)	C	D	E	F
01742	32x32x25	25-20	40	22	19	58	55
01743	40x40x32	32-25	65	26	22	87	63
01744	50x50x40	40-32	130	31	26	97	88
01745	63x63x50	50-40	202	38	31	117	106
01746	75x75x63	65-50	313	45	38	121	141

199/200

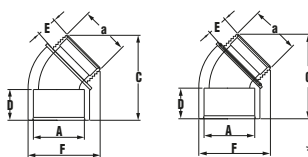

*Modelo con junta tórica

Codo 45° encolar R/M
45° elbow plain/F. threaded
Coude 45° à collar/tarudé

CÓDIGO / CODE	CÓDIGO / CODE*	∅ A-a	DN	PESO / WT (g.)	C	D	E	F
02292	02152	32-1"	25	50-52*	54	19	19	57
02293	02153	40-1 1/4"	32	78-81*	62	22	21	85
02294	02154	50-1 1/2"	40	119-124*	85	26	22	94
02295	02155	63-2"	50	220-226*	102	31	26	109
02296	02156	75-2 1/2"	65	320-330*	131	45	29	115

*Con junta tórica / With o-ring

08/38

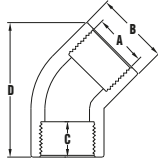

Codo 45° rosca H/H
45° elbow F. threaded/F. threaded
Coude 45° taraudé/taraudé

CÓDIGO / CODE	CÓDIGO / CODE	∅ A	DN	PESO / WT (g.)	B	C	D
02311	-	1/2"-1/2"	15	20	27	16	48
02312	-	3/4"-3/4"	20	27	33	17	53
02313	-	1"-1"	25	54	41	21	63
02314	-	1 1/4"-1 1/4"	32	80	50	23	80
02315	02685	1 1/2-1 1/2"	40	156	61	24	95
02316	02686	2"-2"	50	260	76	28	125
02317	-	2 1/2"-2 1/2"	65	361	89	32	137
02318	-	3"-3"	80	676	107	35	162

917

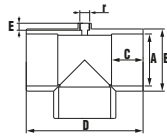

Te "Air"
"Air" 90° tee f/t outlet
Té 90° à coller "Air"

CÓDIGO / CODE	∅ A-r	DN	PESO / WT (g.)	B	C	D	E
01525	110-1"	100	1.465	131	61	238	22
01526	125-1"	110	2.169	148	69	277	22
01531	160-2"	150	3.668	182	86	348	38
01532	200-2"	175	6.600	226	106	408	38

09/39

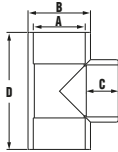

Te 90° encolar
90° Tee
Te 90°

CÓDIGO / CODE	CÓDIGO / CODE	∅ A	DN	PESO / WT (g.)	B	C	D
01142	01380	16	10	15	22	15	48
01075	01381	20	15	21	27	16	56
01025	-	25	20	43	33	19	66
01026	-	32	25	71	41	22	79
01027	-	40	32	110	50	26	95
01028	01385	50	40	183	61	31	114
01029	01386	63	50	292	76	38	141
01030	-	75	65	520	90	44	167
01031	-	90	80	910	108	51	199
01032	-	110	100	1.465	131	61	238
01033	-	125	110	1.987	148	69	277
01034	-	140	125	3.170	164	76	305
01035	-	160	150	3.668	182	86	348
01147	-	180	165	10.200	225	106	408
01036	-	200	175	6.240	225	106	408
01094	-	225	200	9.600	252	119	470
01095	-	250	225	12.505	290	131	252
01096	-	315	300	24.588	352	164	658
01303	-	400	325	39.780	442	206	840

203/204

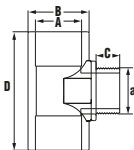

Te 90° encolar R/M encolar
90° Tee plain/threaded/plain
Te 90° à coller/taraudé à coller

CÓDIGO / CODE	CÓDIGO / CODE*	∅ A-a	DN	PESO / WT (g.)	B	C	D
02414	02424	50-1 1/2"	40	188-198*	61	22	114
02415	02425	63-2"	50	295-307*	76	26	141

*Con junta tórica/ With o-ring

11/41



BLANCA

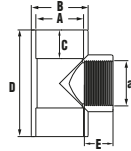

Te 90° encolar R/H centro
90° Tee plain/threaded/plain
Te 90° à coller/tarauté/à coller

CÓDIGO / CODE	CÓDIGO / CODE	∅ A - a	DN	PESO / WT (g.)	B	C	D	E
02221	-	20-1/2"	15	23	27	16	56	16
02222	-	25-3/4"	20	45	33	19	66	17
02223	-	32-1"	25	83	41	22	79	21
02224	-	40-1 1/4"	32	150	50	26	95	23
02225	02665	50-1 1/2"	40	200	61	31	114	24
02226	02666	63-2"	50	327	75	38	141	28
02227	-	75-2 1/2"	65	540	90	44	166	32
02228	-	90-3"	80	977	108	51	199	35
02229	-	110-4"	100	1.502	131	61	238	39

436

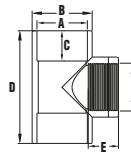

Te 90° enc. R/H centro reforzada
90° Tee plain/threaded/plain
Te 90° à coller/tarauté/à coller

CÓDIGO / CODE	∅ A-a	DN	PESO / WT (g.)	B	C	D	E
02180	20-1/2"	15	34	27	16	56	16
02181	25-3/4"	20	56	33	19	66	17
02182	32-1"	25	96	41	22	79	21
02183	40-1 1/4"	32	165	50	26	95	23
02184	50-1 1/2"	40	218	61	31	114	24
02185	63-2"	50	352	75	38	141	28
02186	75-2 1/2"	65	575	90	45	166	32
02187	90-3"	80	1.022	108	51	199	35
02188	110-4"	100	1.562	131	61	238	39

Refuerzo en acero inoxidable A-2 / Stainless steel reinforcement A-2.

201

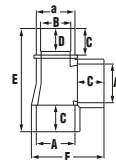

Te 90° encolar H/H/M
90° Tee solvent socket F/F/M
Te 90° à coller F/F/M

CÓDIGO / CODE	∅ A-a-B	DN	PESO / WT (g.)	C	D	E	F
01752	32x32x25	25-20	62	22	19	85	59
01753	40x40x32	32-25	102	26	22	106	74
01754	50x50x40	40-32	175	31	26	125	88
01755	63x63x50	50-40	256	38	31	154	104
01756	75x75x63	65-50	460	45	38	180	130
01758	110x110x90	100-80	1.478	61	51	250	183

202

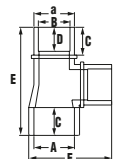

Te 90° encolar H/M/M
90° Tee solvent socket F/M/M
Te 90° à coller F/M/M

CÓDIGO / CODE	∅ A-a-B	DN	PESO / WT (g.)	C	D	E	F
01762	32x32x25	25-20	61	22	19	85	66
01763	40x40x32	32-25	105	26	22	106	81
01764	50x50x40	40-32	180	31	26	125	99
01765	63x63x50	50-40	249	38	31	154	121
01766	75x75x63	65-50	450	45	38	180	143
01768	110x110x90	100-80	1.460	61	51	250	179

13/42

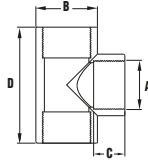

Te 90° rosca H/H
90° Tee threaded
Te 90° à taraudé

CÓDIGO / CODE	CÓDIGO / CODE	∅ A	DN	PESO / WT (g.)	B	C	D
02321	-	1/2"	15	28	27	16	56
02322	-	3/4"	20	45	33	17	66
02323	-	1"	25	86	41	21	99
02324	-	1 1/4"	32	142	50	23	95
02325	02695	1 1/2"	40	235	61	24	114
02326	02696	2"	50	412	76	28	141
02327	-	2 1/2"	65	632	89	32	166
02328	-	3"	80	1.102	107	35	199

834/842



único
mercado

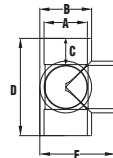

Te 90° encolar 4V
90° Tee solvent socket 4V
Te 90° à coller 4V

CÓDIGO / CODE	CÓDIGO / CODE	∅ A	DN	PESO / WT (g.)	B	C	D	E
01304	01358	50	40	212	61	31	114	88
01305	01359	63	50	336	76	38	141	109
01306	-	75	65	598	90	44	167	130

221

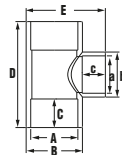

Te reducida 90° encolar R/H centro
90° reducing tee
Te réducteur 90°

CÓDIGO / CODE	∅ A-a	DN	PESO / WT (g.)	B	C	b	c	D	E
02230	25-1/2"	20-15	37	33	19	27	16	66	47
02231	32-1/2"	25-15	61	40	22	27	16	79	57
02232	32-3/4"	25-20	65	40	22	32	19	79	58
02233	40-1/2"	32-15	87	50	22	27	16	95	66
02234	40-3/4"	32-20	101	50	26	32	19	95	67
02235	40-1"	32-25	105	50	26	40	22	95	70
02236	50-3/4"	40-20	149	60	26	32	19	114	78
02237	50-1"	40-25	152	60	31	40	22	114	80
02238	50-1 1/4"	40-32	161	60	31	50	26	114	84
02239	63-1"	50-25	300	76	31	40	22	142	96
02240	63-1 1/4"	50-32	303	76	38	50	26	142	100
02241	63-1 1/2"	50-40	318	76	38	62	31	142	102
02242	75-1"	65-25	531	91	38	41	22	171	109
02243	75-1 1/4"	65-32	465	89	45	50	26	167	114
02244	75-1 1/2"	65-40	163	89	44	60	31	167	117
02245	75-2"	65-50	574	89	44	76	38	167	126
02246	90-1 1/4"	80-32	832	107	44	50	26	200	132
02247	90-1 1/2"	80-40	951	107	51	60	31	200	140
02248	90-2"	80-50	940	107	51	76	38	200	140
02249	90-2 1/2"	80-65	947	107	51	92	44	200	150
02252	110-2"	100-50	1.299	130	61	76	38	238	165
02253	110-3"	100-80	1.345	130	61	110	39	238	173

893

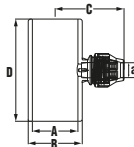

Te reducida 90° salida fitting
90° Reducing tee compression fitting outlet
 Té réduite à 90°

CÓDIGO / CODE	A-a	PESO / WT (g.)	B	C	D
01879	50-20	190	60	88	114
01880	50-25	206	60	91	114
01881	63-20	305	76	95	141
01882	63-25	330	76	98	141
01885	90-32	1030	108	122	199
01886	90-63	1400	108	168	199

10/40

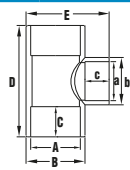

Te reducida 90° encolar
90° reducing tee
 Te réducteur 90°

CÓDIGO / CODE	CÓDIGO / CODE	Ø A-a	DN	PESO / WT (g.)	B	C	b	c	D	E
01201	-	25/20	20-15	37	33	19	27	16	66	47
01209	-	32/20	25-15	61	40	22	27	16	79	57
01202	-	32/25	25-20	65	40	22	32	19	79	58
01210	-	40/20	32-15	87	50	26	27	16	95	66
01211	-	40/25	32-20	101	50	26	32	19	95	67
01203	-	40/32	32-25	105	50	26	40	22	95	70
01213	01393	50/25	40-20	149	60	31	32	19	114	78
01214	01394	50/32	40-25	152	60	31	40	22	114	80
01204	01395	50/40	40-32	161	60	31	50	26	114	84
01215	-	63/20	50-15	295	76	38	27	16	142	90
01216	-	63/25	50-20	298	76	38	32	19	142	93
01217	01396	63/32	50-25	300	76	38	40	22	142	96
01218	01397	63/40	50-32	303	76	38	50	26	142	100
01205	01398	63/50	50-40	318	76	38	62	31	142	102
01219	-	75/32	65-25	531	91	44	41	22	171	109
01220	-	75/40	65-32	465	89	44	50	26	167	114
01221	-	75/50	65-40	163	89	44	60	31	167	117
01206	-	75/63	65-50	574	89	44	76	38	167	126
01222	-	90/40	80-32	832	107	51	50	26	200	132
01223	-	90/50	80-40	951	107	51	60	31	200	140
01224	-	90/63	80-50	940	107	51	76	38	200	140
01207	-	90/75	80-65	947	107	51	92	44	200	150
01225	-	110/50	100-40	1.200	130	61	60	31	237	158
01226	-	110/63	100-50	1.292	130	61	76	38	237	165
01227	-	110/75	100-65	1.307	130	61	92	44	237	169
01208	-	110/90	100-80	1.316	130	61	110	51	237	173
01228	-	125/63	110-50	1.760	145	69	76	38	277	173
01229	-	125/75	110-65	1.748	145	69	89	44	277	180
01230	-	125/90	110-80	1.825	145	69	108	51	277	188
01231	-	125/110	110-100	1.924	145	69	130	61	277	197
01232	-	140/75	125-65	2.407	163	76	89	44	295	195
01233	-	140/90	125-80	2.498	163	76	107	51	295	202
01234	-	140/110	125-100	2.576	163	76	130	61	295	212
01235	-	140/125	125-110	2.640	163	76	145	69	295	220
01236	-	160/90	150-80	3.520	186	86	107	51	334	237
01237	-	160/110	150-100	3.840	186	86	130	61	334	247
01238	-	160/125	150-110	3.900	186	86	145	69	334	255
01239	-	160/140	150-125	4.125	186	86	163	76	334	262
01240	-	200/110	175-100	5.990	226	106	131	61	408	287
01241	-	200/125	175-110	6.489	226	106	148	69	408	295
01242	-	200/140	175-125	6.614	226	106	164	76	408	302
01243	-	200/160	175-150	6.936	226	106	182	82	408	308
01580	-	225/125	200-110	7.750	252	119	148	69	470	321
01581	-	225/140	200-125	7.980	252	119	164	76	470	328
01582	-	225/160	200-150	8.160	252	119	182	86	470	338
01583	-	225/200	200-175	8.630	252	119	226	106	470	358

435/439

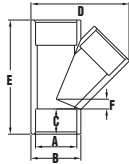

Te 45° encolar
45° tee
Te 45°

CÓDIGO / CODE	CÓDIGO / CODE	∅ A	DN	PESO / WT (g.)	B	C	D	E	F
01340	01540	16	10	26	22	15	48	59	6
01341	01541	20	15	34	27	16	55	68	7
01342	-	25	20	68	33	19	67	81	7
01343	-	32	25	125	41	22	82	96	8
01344	-	40	32	225	50	26	99	116	10
01345	01545	50*	40	300	61	31	121	142	13
01346	01546	63*	50	475	76	38	150	174	15
01347	-	75*	65	852	90	44	180	207	17
01348	-	90*	80	1.501	108	51	212	244	20
01349	-	110*	100	2.389	131	61	260	298	27
01360	-	125*	110	3.245	148	69	292	337	30
01361	-	140*	125	5.230	164	76	328	379	34
01362	-	160*	150	6.020	182	86	368	429	41
01363	-	200*	175	11.800	226	106	465	529	49

*PN 10 bar

625/629



SERIE "AIR"
ÚNICO en el mercado

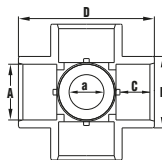

Cruz 90° encolar "AIR" salida encolar
"AIR" 90° Cross s.socket outlet
Croix 90° "AIR" extrémités à coller

CÓDIGO / CODE	CÓDIGO / CODE	∅ A-a	DN	PESO / WT (g.)	B	C	D
01660	01566	20-20	15	51	27	16	56
01661	-	25-20	20	92	33	19	66
01662	-	32-20	25	135	41	22	82
01665	01571	50-20	40	310	63	31	121
01666	01572	50-25	40	324	63	31	121

281/451



SERIE "AIR"
ÚNICO en el mercado

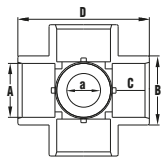

Cruz 90° encolar "AIR" salida R/H
"AIR" 90° Cross
Croix 90° "AIR"

CÓDIGO / CODE	CÓDIGO / CODE	∅ A-a	DN	PESO / WT (g.)	B	C	D
01730	01556	20-1/2"	15	51	27	16	56
01731	-	25-1/2"	20	92	33	19	66
01732	-	32-1/2"	25	135	41	22	82
01735	01561	50-1/2"	40	310	63	31	121
01736	01562	50-3/4"	40	324	63	31	121

15/45

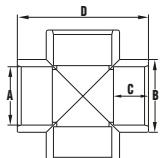

Cruz 90° encolar
90° Cross
Croix 90°

CÓDIGO / CODE	CÓDIGO / CODE	∅ A	DN	PESO / WT (g.)	B	C	D
01311	01401	20	15	34	27	16	56
01312	-	25	20	67	33	19	66
01313	-	32	25	112	41	22	82
01244	-	40	32	169	50	26	98
01245	01405	50	40	288	63	31	121
01246	01406	63	50	495	75	38	160
01247	-	75	65	670	89	44	166
01248	-	90	80	1.142	108	51	203
01249	-	110	100	1.812	131	61	240
01250	-	125	110	2.311	145	69	277
01251	-	140	125	3.200	164	76	305
01252	-	160	150	4.220	183	86	348
01253	-	200	175	6.850	225	106	408

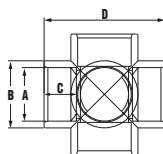

835/843

BLANCA

Cruz 90° encolar 5V
90° Cross solvent socket 5V
Croix 90° à coller 5V

CÓDIGO / CODE	CÓDIGO / CODE	Ø A	DN	PESO / WT (g.)	B	C	D
01595	01420	50	40	288	63	31	121
01596	01421	63	50	495	75	38	160
01597	-	75	65	670	89	44	166

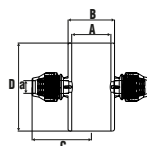

894

Cruz reducida 90° salida fitting
90° red. cross comp. fitting outlet
Croix reduite à 90° sortie raccord à compression

CÓDIGO / CODE	A-a	PESO / WT (g.)	B	C	D
01800	50-20	210	60	88	114
01801	50-25	226	60	91	114
01802	63-20	320	76	95	141
01803	63-25	368	76	98	141
01806	90-32	1080	108	122	199
01807	90-63	1645	108	168	199



BLANCA

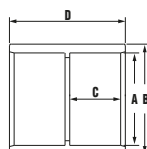

12/43

Manguito encolar
Coupling
Manchon à coller

CÓDIGO / CODE	CÓDIGO / CODE	Ø A	DN	PESO / WT (g.)	B	C	D
01143	01410	16	10	8	22	15	32
01076	01411	20	15	13	27	16	35
01037	-	25	20	21	33	19	42
01038	-	32	25	34	41	22	47
01039	-	40	32	64	50	26	55
01040	01415	50	40	107	63	31	67
01041	01416	63	50	145	76	38	81
01042	-	75	65	277	90	44	92
01043	-	90	80	488	108	51	108
01044	-	110	100	734	131	61	129
01045	-	125	110	987	148	69	146
01046	-	140	125	1.088	164	76	162
01047	-	160	150	1.369	183	86	182
01149	-	180	165	4.390	225	106	229
01048	-	200	175	2.646	225	106	229
01097	-	225	200	3.702	252	119	250
01098	-	250	225	5.272	284	131	275
01099	-	315	300	9.884	352	164	340
01300	-	400	325	12.800	432	206	424



BLANCA

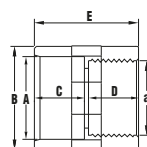

14/44

Manguito unión mixto
Union bush
Manchon fileté mixte

CÓDIGO / CODE	CÓDIGO / CODE	Ø A-a	DN	PESO / WT (g.)	B	C	D	E
02010	-	20-1/2"	15	16	28	17	16	36
02011	-	25-3/4"	20	24	34	20	17	41
02012	-	32-1"	25	40	42	22	21	48
02013	-	40-1 1/4"	32	66	51	27	23	53
02014	02575	50-1 1/2"	40	100	61	32	24	61
02015	02576	63-2"	50	153	75	39	28	72
02016	-	75-2 1/2"	65	270	90	44	32	85
02017	-	90-3"	80	457	110	51	35	100
02018	-	110-4"	100	615	129	61	39	108

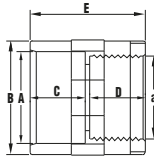

437

Manguito mixto reforzado
Reinforced union bush
Manchon fileté mixte renforcé

CÓDIGO / CODE	∅ A-a	DN	PESO / WT (g.)	B	C	D	E
02190	20-1/2"	15	27	28	17	16	36
02191	25-3/4"	20	35	34	20	17	41
02192	32-1"	25	53	42	22	21	48
02193	40-1 1/4"	32	81	51	27	23	53
02194	50-1 1/2"	40	118	61	32	24	61
02195	63-2"	50	178	75	39	28	72
02196	75-2 1/2"	65	305	90	44	32	85
02197	90-3"	80	518	110	51	35	100

Refuerzo en acero inoxidable A-2 / Stainless steel reinforcement A-2.

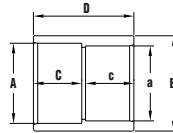

895

Manguito transición normativa BS-DIN
Standard transition coupling BS-DIN
Manchon raccordement normé BS-DIN

CÓDIGO / CODE	A-a	PESO / WT (g.)	B	C	c	D
01900	90-3"	495	108	51	51	108
01901	110-4"	720	131	61	63	129
01903	160-6"	1320	183	86	90	182

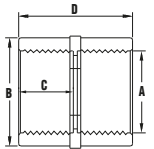

16/46

Manguito unión R/H
Union bush female threaded
Manchon taraudée

CÓDIGO / CODE	CÓDIGO / CODE	∅ A	DN	PESO / WT (g.)	B	C	D
02050	-	1/2"	15	18	27	16	35
02051	-	3/4"	20	27	33	19	41
02052	-	1"	25	44	41	22	47
02053	-	1 1/4"	32	72	50	26	55
02054	02585	1 1/2"	40	110	61	31	65
02055	02586	2"	50	169	75	38	79
02056	-	2 1/2"	65	297	90	44	92
02058	-	3"	80	503	108	51	107
02059	-	4"	100	632	131	61	128

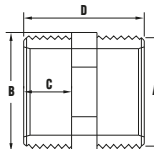

17/47

Machón M/M
Nipple male-male
Mamelon mâle-mâle

CÓDIGO / CODE	CÓDIGO / CODE	∅ A	DN	PESO / WT (g.)	B	C	D
02401	02701	1/2"-1/2"	15	14	29	11	40
02402	02702	3/4"-3/4"	20	21	34	16	44
02403	02703	1"-1"	25	37	44	19	50
02404	02704	1 1/4"-1 1/4"	32	54	50	21	55
02405	02705	1 1/2"-1 1/2"	40	71	60	22	57
02406	02706	2"-2"	50	108	70	26	65
02407	-	2 1/2"-2 1/2"	65	175	80	31	75
02408	-	3"-3"	80	320	108	33	81
02409	-	4"-4"	100	510	135	38	91

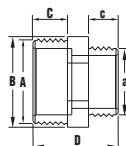

18/48

BLANCA

Machón M/M reducido
Reducing nipple male-male
Mamelon réduit mâle-mâle

CÓDIGO / CODE	CÓDIGO / CODE	Ø A-a	DN	PESO / WT (g.)	B	c	C	D
02447	02720	3/4"-1/2"	20-15	19	34	11	16	42
02448	02721	1"-1/2"	25-15	30	44	11	19	47
02449	02722	1"-3/4"	25-20	33	44	16	19	47
02450	02723	1 1/4"-1/2"	32-15	44	50	11	21	49
02451	02724	1 1/4"-3/4"	32-20	47	50	16	21	50
02452	02725	1 1/4"-1"	32-25	50	50	19	21	53
02453	02712	1 1/2"-1/2"	40-15	58	60	11	22	49
02454	02713	1 1/2"-3/4"	40-20	59	60	16	22	51
02455	02714	1 1/2"-1"	40-25	62	60	19	22	54
02456	02715	1 1/2"-1 1/4"	40-32	67	60	21	22	56
02457	02716	2"-3/4"	50-20	90	70	16	26	56
02458	02717	2"-1"	50-25	93	70	19	26	60
02459	02718	2"-1 1/4"	50-32	95	70	21	26	61
02460	02719	2"-1 1/2"	50-40	98	70	22	26	61
02461	-	2 1/2"-2"	65-50	140	80	31	26	72
02462	-	3"-2"	80-50	215	108	33	26	74
02463	-	3"-2 1/2"	80-65	265	108	33	31	73
02464	-	4"-3"	100-80	425	115	38	33	86

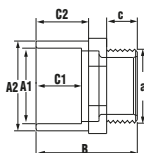

20/49

BLANCA

Machón mixto
Adaptor nipple
Embout fileté

CÓDIGO / CODE	CÓDIGO / CODE	Ø A1-A2-a	PESO / WT (g.)	B	C1	C2	c
02037	-	16-20-1/2"	8	35	15	16	12
02000	-	16-20-3/8"	7	35	15	16	12
02001	-	20-25-1/2"	14	38	16	19	14
02728	-	25-32-1/2"	24	48	19	22	14
02002	-	25-32-3/4"	26	51	19	22	17
02729	-	25-32-1"	29	53	19	22	19
02731	-	32-40-3/4"	38	54	22	26	16
02732	-	32-40-1"	41	57	22	26	19
02733	-	32-40-1 1/4"	45	59	22	26	22
02741	02563	40-50-1"	72	64	26	31	19
02742	02564	40-50-1 1/4"	75	65	26	31	22
02743	02565	40-50-1 1/2"	79	66	26	31	22
02751	02566	50-63-1"	114	71	31	38	19
02752	02567	50-63-1 1/4"	118	74	31	38	22
02753	02568	50-63-1 1/2"	121	74	31	38	22
02754	02569	50-63-2"	128	78	31	38	26
02761	-	63-75-1"	164	79	38	44	19
02762	-	63-75-1 1/4"	168	81	38	44	22
02763	-	63-75-1 1/2"	172	81	38	44	22
02764	-	63-75-2"	173	85	38	44	26
02765	-	63-75-2 1/2"	200	89	38	44	31
02769	-	75-90-2"	275	93	44	51	26
02766	-	75-90-2 1/2"	294	98	44	51	31
02770	-	75-90-3"	345	100	44	51	33
02771	-	90-110-2 1/2"	490	109	51	61	31
02767	-	90-110-3"	493	111	51	61	33
02800	-	90-110-4"	525	118	51	61	40
02768	-	110-125-3"	508	120	61	69	33
02009	-	110-125-4"	532	127	61	69	40



NGTUB

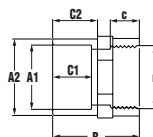

905

Machón mixto hembra
Adaptor nipple
Raccord mixte femelle

CÓDIGO / CODE	A1-A2 x r	PESO / WT (g.)	B	C1	C2	c
02125	50-63x2"	195	81	31	38	108

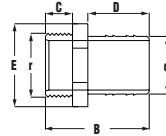

906

Espiga R/M
Spigot connection male thread
Raccord mixte cannelé fileté

CÓDIGO / CODE	r x d	PESO / WT (g.)	B	C	D	E
02961	3/4"-20	17	62	17	36	27
02962	1"-32	55	78	21	36	47
02964	1 1/2"-50	83	89	22	50	57
02965	2"-63	110	100	26	65	60

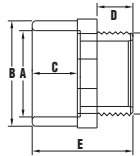

19/52

Terminal R/Macho
Adaptor bushes
Embout fileté

CÓDIGO / CODE	CÓDIGO / CODE	Ø A-a	DN	PESO / WT (g.)	B	C	D	E
02000	02250	16-3/8"	10	10	22	14	11	32
02001	02251	20-1/2"	15	15	27	16	14	38
02002	-	25-3/4"	20	24	33	19	16	51
02003	-	32-1"	25	41	41	22	19	52
02004	-	40-1 1/4"	32	46	50	26	21	56
02005	02555	50-1 1/2"	40	107	63	31	22	67
02006	02556	63-2"	50	137	76	38	26	73
*02950	-	63-2" L	50	141	76	38	38	85
02007	-	75-2 1/2"	65	212	90	44	30	87
*02951	-	75-2 1/2" L	65	219	90	44	42	99
02008	-	90-3"	80	332	108	51	33	96
02009	-	110-4"	100	549	131	61	38	127

* Terminal rosca macho con rosca larga / Adaptor bush with long thread.

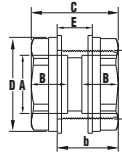

406/407

Pasamuros
Tank adaptor
Traverse de paroi

CÓDIGO / CODE	CÓDIGO / CODE	Ø A-a	DN	PESO / WT (g.)	B	b	C	D	E
02780	-	20-1"	15	79	16	47	62	50	38
02772	02872	25-1"	20	76	19	47	62	50	38
02773	02873	32-1 1/4"	25	112	21	53	69	64	33
02774	02874	40-2"	32	275	26	53	74	81	30
02775	02875	50-2"	40	208	31	53	74	81	30
02777	-	75-3"	65	410	44	78	104	108	52
02778	-	90-4"	80	890	51	90	120	140	60
*02781	-	20-1"	15	79	16	47	62	50	38
*02782	*02882	25-1"	20	76	19	47	62	50	38
*02783	*02883	32-1 1/4"	25	112	21	53	69	64	33
*02784	*02884	40-2"	32	275	26	53	74	81	30
*02785	*02885	50-2"	40	208	31	53	74	81	30
*02787	-	75-3"	65	410	44	78	104	108	52
*02788	-	90-4"	80	890	51	90	120	140	60

* Juntas de Viton / Viton gasket.

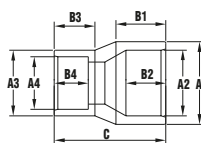

545

Reducción cónica H-M
Conical reducing
Manchon réduit conique

CÓDIGO / CODE	Ø A1/A2/A3/A4	PESO / WT (g.)	B1	B2	B3	B4	C
01772	40/32/32/25	32	26	22	22	19	55
01773	50/40/40/32	57	31	26	26	22	66
01774	63/50/50/40	110	38	31	31	26	80
01775	75/63/63/50	165	44	38	38	31	93

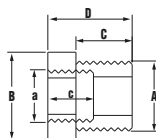

Reducción roscada R/M-R/H
Threaded reducer male-female
Reduction fileté-taraudée

807

CÓDIGO / CODE	Ø A-a	PESO / WT (g.)	B	C	c	D
02471	1/2" - 1/8"	9,2	24	15	12	25
02470	1/2" - 1/4"	8,8	24	15	14	25
02469	1/2" - 3/8"	8,2	24	15	14	25
02472	3/4" - 1/2"	18	34	16	18	43
02473	1" - 1/2"	32	44	19	18	47
02474	1" - 3/4"	37	44	19	19	48
02484	1 1/4" - 3/4"	53	50	21	19	48
02475	1 1/4" - 1"	57	50	21	19	53
02476	1 1/2" - 1 1/4"	83	58	21	25	56
02477	2" - 1 1/4"	109	72	26	25	60
02478	2" - 1 1/2"	114	72	26	25	60
02479	2 1/2" - 1 1/4"	150	78	31	29	66
02480	2 1/2" - 2"	165	78	31	31	70
02481	3" - 2 1/2"	255	92	33	38	79

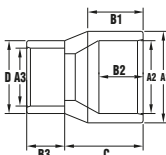

Reducción cónica
Reducing socket
Manchon réduit conique

23/51

CÓDIGO / CODE	CÓDIGO / CODE	Ø A1/A2/A3	DN	PESO / WT (g.)	B1	B2	B3	C	D
01078	-	32/25/20	15	19	22	19	16	30	27
01321	-	40/32/20	15	28	26	22	17	34	27
01103	-	40/32/25	20	33	26	22	19	36	33
01322	01462	50/40/20	15	48	31	26	16	45	27
01323	01463	50/40/25	20	53	31	26	19	44	33
01104	01425	50/40/32	25	58	31	26	22	44	41
01324	01464	63/50/25	20	90	38	31	19	54	33
01325	01465	63/50/32	25	97	38	31	22	42	41
01105	01426	63/50/40	32	107	38	31	26	54	50
01326	01466	75/63/32	25	112	44	38	22	62	41
01327	01467	75/63/40	32	125	44	38	26	64	50
01106	01427	75/63/50	40	148	44	38	31	62	61
01328	-	90/75/40	32	197	51	44	27	75	50
01329	-	90/75/50	40	220	51	44	31	75	61
01107	-	90/75/63	50	256	51	44	38	74	76
01330	-	110/90/50	40	389	61	51	29	90	61
01331	-	110/90/63	50	428	61	51	38	90	75
01108	-	110/90/75	65	489	61	51	44	88	90
01332	-	125/110/63	50	426	69	61	38	101	75
01333	-	125/110/75	65	497	69	61	44	100	90
01109	-	125/110/90	80	523	69	61	51	100	108
01334	-	140/125/75	65	641	76	69	44	111	90
01335	-	140/125/90	80	657	76	69	51	112	105
01110	-	140/125/110	100	845	76	69	61	111	131
01336	-	160/140/90	80	918	86	76	51	126	105
01337	-	160/140/110	100	1.145	86	76	61	126	131
01111	-	160/140/125	110	1.288	86	76	69	126	148
01113	-	EXT 200/INT 160	150	2.540	106	-	86	156	182
01134	-	200/180/110	100	1.890	106	100	61	154	131
01135	-	200/180/125	110	1.920	106	100	69	154	148
01136	-	200/180/140	125	1.980	106	100	76	154	157
01139	-	225/200/125	110	2.430	119	106	69	171	148
01138	-	225/200/140	125	2.480	119	106	76	171	157
01112	-	225/200/160	150	2.567	119	106	86	171	182
01114	-	250/225/200	175	4.975	131	119	106	194	225
01115	-	250/225/160	150	4.345	131	119	86	194	182
01116	-	315/280/200	175	8.690	164	131	106	233	225
01117	-	315/280/160	150	8.075	164	131	86	233	182

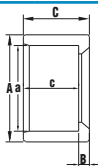

Casquillo reductor
Reducing bush
Réduction simple

21/50

CÓDIGO / CODE	CÓDIGO / CODE	∅ A-a	DN	PESO / WT (g.)	B	c	C
01144	01496	20/16*	10	4	2	14	16
01061	-	25/20*	15	5	3	16	19
01170	-	32/20	20	12	6	16	22
01062	-	32/25*	20	10	6	19	22
01171	-	40/20	25	21	10	16	26
01172	-	40/25	25	22	7	19	26
01063	-	40/32*	25	15	4	22	26
01173	01503	50/20	32	33	15	16	31
01174	01504	50/25	32	35	12	19	31
01175	01505	50/32	32	39	9	22	31
01064	01435	50/40*	32	30	5	26	31
01178	01508	63/32	40	71	15	23	38
01179	01509	63/40	40	77	12	26	38
01065	01436	63/50*	40	57	7	31	38
01183	-	75/40	50	119	18	26	44
01184	-	75/50	50	118	12	32	44
01066	-	75/63*	50	79	6	38	44
01189	-	90/50	65	177	19	32	51
01190	-	90/63	65	164	12	39	51
01067	-	90/75*	65	135	8	44	52
01196	-	110/63	80	296	22	39	61
01197	-	110/75	80	315	17	44	61
01068	-	110/90*	80	250	10	51	61
01198	-	125/75	65	385	25	44	69
01199	-	125/90	80	415	18	51	69
01069	-	125/110*	100	273	8	61	69
01122	-	140/90	80	512	25	51	76
01123	-	140/110*	100	560	15	61	76
01070	-	140/125*	110	317	7	69	76
01124	-	160/90	80	605	35	51	86
01125	-	160/110	100	685	25	61	86
01126	-	160/125	110	765	17	69	86
01071	-	160/140*	125	518	10	76	86
01127	-	200/110	100	2.016	45	61	106
01128	-	200/125	110	2.050	37	69	106
01129	-	200/140	125	1.950	30	76	106
01072	-	200/160*	150	1.670	20	86	106
01100	-	225/200*	175	1.416	13	106	119
01130	-	250/160	175	2.822	15	120	135
01131	-	250/200*	200	2.724	29	106	135
01101	-	250/225*	200	1.756	13	121	134
01132	-	315/200	175	7.900	46	120	166
01133	-	315/225	225	7.540	60	106	166
01102	-	315/250*	150	4.336	33	131	164
01308	-	400/250	300	11.142	40	165	205
01309	-	400/315*	225	9.700	74	131	205

* Casquillo reducido macizo / Solid reducing bush.

Tapón encolar
Caps, solvent socket
Bouchon à coller

24/53

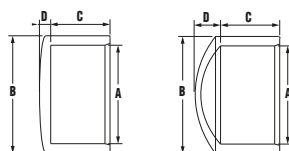

CÓDIGO / CODE	CÓDIGO / CODE	Ø A	PESO / WT (g.)	B	C	D
*01145	*01440	16	4	22	15	6
*01077	*01441	20	6	25	16	8
*01049	-	25	13	32	19	9
*01050	-	32	21	40	22	10
*01051	-	40	39	50	26	12
*01052	*01445	50	80	63	31	15
01053	01446	63	121	75	38	17
01054	-	75	189	91	44	19
01055	-	90	320	111	51	23
01056	-	110	530	132	61	28
01057	-	125	718	148	69	32
01058	-	140	1.061	168	76	36
01059	-	160	1.254	186	86	40
01314	-	180	3.130	225	106	46
01060	-	200	2.005	225	106	46
01119	-	225	2.475	252	119	362
01120	-	250	3.180	282	131	60
01121	-	315	5.630	357	164	70

* Tapón plano / Plain cap.

Tapón R/Hembra
Cap female thread
Bouchon taraudé

25/705

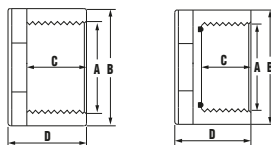

*Modelo con junta tórica

CÓDIGO / CODE	CÓDIGO / CODE*	Ø A	PESO / WT (g.)	B	C	D
02040	02540	1/2"	12-11*	29	16-13*	24-24*
02041	02541	3/4"	16-18*	34	19-15*	28-28*
02042	02542	1"	26-33*	44	22-18*	33-33*
02043	02543	1 1/4"	42-53*	47	26-20*	37-35*
02044	02544	1 1/2"	74-73*	55	31-20*	43-37*
02045	02545	2"	128-123*	69	38-25*	51-45*
02046	02546	2 1/2"	187-210*	87	44-29*	64-54*
02047	02547	3"	150-369*	103	51-32*	76-63*
02048	02548	4"	525-495*	130	61-36*	91-72*

*Con junta tórica/ With o-ring

Tapón R/Macho
Plug male thread
Bouchon fileté

22/440

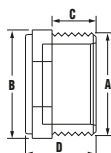

CÓDIGO / CODE	CÓDIGO / CODE	Ø A	PESO / WT (g.)	B	C	D
02019	02850	1/2"	14	29	14	31
02020	02851	3/4"	19	34	16	32
02021	02852	1"	33	44	19	35
02022	02853	1 1/4"	38	47	21	38
02023	02854	1 1/2"	47	55	21	40
02024	02855	2"	80	69	26	46
02025	-	2 1/2"	134	87	30	51
02026	-	3"	211	103	33	58
02027	-	4"	318	130	38	65

Colectores
PVC-U

409/408



SISTEMA NOTUB

BLANCA

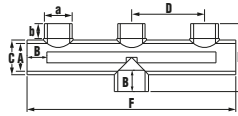

Colector 3 vías encolar
3-way manifold
Collecteur 3 entrées

CÓDIGO / CODE	CÓDIGO / CODE	Ø A-a	DN	PESO / WT (g.)	b	B	C	D	E	F
01269	01278	32	25	470	22	22	40	115	88	308
01270	01280	50	40	677	26	34	61	131	123	393
*01272	*01282	50-63	40-50	725	26	38*	61	131	128	393
01271	01281	63	50	1.143	26	38	75	165	151	460

* Boca central Ø63 / Central outlet Ø63.

409 bis/408 bis



SISTEMA NOTUB

ÚNICO mercado

BLANCA

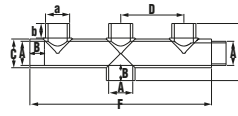

Colector 3 vías enc. salida lateral Notub
3-way manifold Notub side outlet
Collecteur 3 entrées sortie latérale

CÓDIGO / CODE	CÓDIGO / CODE	Ø A-a	DN	PESO / WT (g.)	b	B	C	D	E	F
01719	01447	50	40	707	26	34	61	131	123	424
*01720	*01448	50-63	40-50	755	26	38*	61	131	128	424
01721	01449	63	50	1.188	26	38	75	165	151	498

* Boca central Ø63 / Central outlet Ø63.

626/630



SISTEMA NOTUB

BLANCA

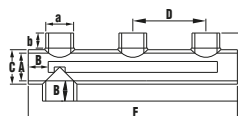

Colector 3 vías B/lateral encolar
3-way manifold lateral solvent socket outlet
Collecteur a 3 voies sortie latérale

CÓDIGO / CODE	CÓDIGO / CODE	Ø A-a	DN	PESO / WT (g.)	b	B	C	D	E	F
01273	01283	32	25	470	21	22	40	115	88	308
01275	01285	50	40	677	21	34	61	131	123	393
01276	01286	63	50	1.143	26	38	75	165	151	460

626 bis/630 bis



SISTEMA NOTUB

ÚNICO mercado

BLANCA

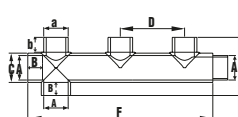

Colector 3 vías B/lateral enc. salida Notub
3-way manifold Notub side outlet
Collecteur d'aspiration 3 entrées mixtes

CÓDIGO / CODE	CÓDIGO / CODE	Ø A-a	DN	PESO / WT (g.)	b	B	C	D	E	F
01722	01450	50	40	707	21	34	61	131	146	424
01723	01451	63	50	1.188	26	38	75	165	151	498

283/496



BLANCA

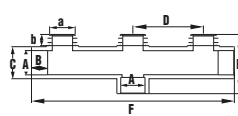

Colector 3 vías R/Macho
3-way manifold male threaded
Collecteur 3 entrées filetées

CÓDIGO / CODE	CÓDIGO / CODE	Ø A-a	DN	PESO / WT (g.)	b	B	C	D	E	F
02373	02863	1" -1"	25	520	19	22	40	115	85	308
02375	02865	2"-1 1/2"	50-40	1.052	21	38	75	165	97	460
02376	02866	2"-2"	50	1.173	26	38	75	165	102	460



703/704

BLANCA

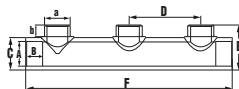

Colector distribuidor encolar macho

3-way distributor

Collecteur 3 entrées a coller

CÓDIGO / CODE	CÓDIGO / CODE	Ø A-a	DN	PESO / WT (g.)	b	B	C	D	E	F
01292	01287	32	32	450	21	22	40	115	67	308
01294	01289	50	50-40	645	21	34	61	131	86	393
01293	01288	63	50	1.090	26	38	75	165	102	460



703 bis/704 bis

BLANCA

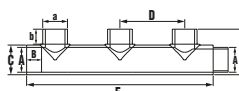

Colector distribuidor enc. salida Notub

Solvent socket PVC Manifold Notub side outlet

Collecteur 3 entrées sortie latérale

CÓDIGO / CODE	CÓDIGO / CODE	Ø A-a	DN	PESO / WT (g.)	b	B	C	D	E	F
01724	01452	50	40	645	21	34	61	131	86	424
01725	01453	63	50	1.090	26	38	75	165	102	498



282/452

BLANCA

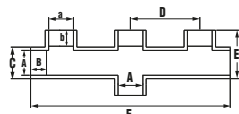

Colector 3 vías R/H

3-way manifold female threaded

Collecteur 3 entrées taraudées

CÓDIGO / CODE	CÓDIGO / CODE	Ø A-a	DN	PESO / WT (g.)	b	B	C	D	E	F
02383	02893	1" -1"	25	480	22	22	40	115	78	308
02385	02895	2"-1 1/2"	50-40	1.103	21	38	75	165	115	460
02386	02896	2"-2"	50	1.201	26	38	75	165	115	460



531/497

BLANCA

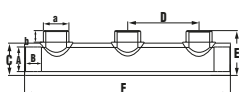

Colector distribuidor R/M

3-way distributor male threaded

Collecteur 3 entrées filetés

CÓDIGO / CODE	CÓDIGO / CODE	Ø A-a	DN	PESO / WT (g.)	b	B	C	D	E	F
02333	02833	1" -1"	25	465	19	22	40	115	67	308
02335	02835	2"-1 1/2"	50-40	1.052	21	38	75	165	97	460
02346	02836	2"-2"	50	1.173	26	38	75	165	102	460



532/511

BLANCA

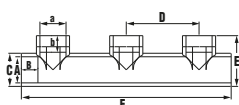

Colector distribuidor R/H

3-way manifold female threaded

Collecteur 3 entrées taraudées

CÓDIGO / CODE	CÓDIGO / CODE	Ø A-a	DN	PESO / WT (g.)	b	B	C	D	E	F
02353	02843	1" -1"	25	420	22	22	40	115	61	308
02355	02845	2"-1 1/2"	50-40	1.103	21	38	75	165	115	460
02366	02846	2"-2"	50	1.201	26	38	75	165	115	460

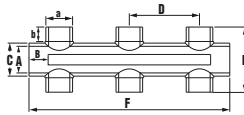

760/762

BLANCA

Colector 6 vías encolar
6-way manifold solvent socket outlet
Collecteur 6 entrées taraudées

CÓDIGO / CODE	CÓDIGO / CODE	Ø A-a	DN	PESO / WT (g.)	b	B	C	D	E	F
01682	01692	32	25	564	22	22	40	115	88	308
01684	01694	50	50-40	815	26	34	61	131	123	393
01685	01695	63	50	1.380	26	38	75	165	151	460

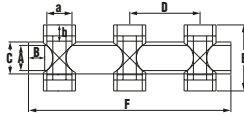

761/844

BLANCA

Colector 6 vías R/H
6-way manifold female threaded outlet
Collecteur d'aspiration 6 entrées mixtes

CÓDIGO / CODE	CÓDIGO / CODE	Ø A-a	DN	PESO / WT (g.)	b	B	C	D	E	F
02387	02847	1" -1"	25	575	22	22	40	115	78	308
02389	02848	2"-1 1/2"	50-40	1.325	21	38	75	165	115	460
02390	02849	2"-2"	50	1.440	26	38	75	165	115	460

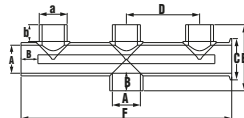

836

Colector 3 vías Net. Syst. /Enc. H
3 channel manifold Net. syst. - solvent socket

CÓDIGO / CODE	Ø A-a	DN	PESO / WT (g.)	b	B	C	D	E	F
1N885	50	40	677	26	34	61	131	123	393
1N886	50-63	40-50	725	26	38	61	131	128	393
1N887	63	50	1.143	26	38	75	165	151	460

* Boca central Ø63

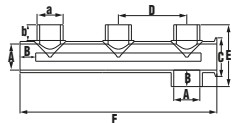

837

Colector 3 vías B/Lateral Net. Syst. /Enc. H
Lateral outlet 3 channel manifold
Net. Syst. - solvent socket

CÓDIGO / CODE	Ø A-a	DN	PESO / WT (g.)	b	B	C	D	E	F
1N888	50	40	677	21	34	61	131	123	393
1N889	63	50	1.143	26	38	75	165	151	460

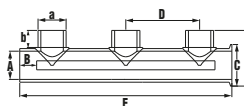

838

Colector distribuidor Net. Syst. /Enc. H
Manifold Net. Syst. - solvent socket

CÓDIGO / CODE	Ø A-a	DN	PESO / WT (g.)	b	B	C	D	E	F
1N890	50	40	677	21	34	61	131	123	393
1N891	63	50	1.143	26	38	75	165	151	460

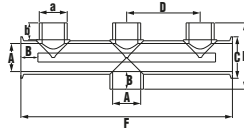

839

Colector 3 vías Net. Syst. /Net. Syst.
3 channel manifold Net. Syst. - Net. Syst.

CÓDIGO / CODE	∅ A-a	DN	PESO / WT (g.)	b	B	C	D	E	F
1N892	50	40	677	26	34	61	131	123	393
1N893	50-63	40-50	725	26	38	61	131	128	393
1N894	63	50	1.143	26	38	75	165	151	460

* Boca central ∅63 / Central outlet ∅63.

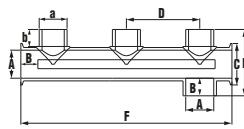

840

Colector 3 vías B/Lateral Net. Syst. /Net. Syst.
Lateral outlet 3 channel manifold
Net. Syst./ Net. Syst.

CÓDIGO / CODE	∅ A-a	DN	PESO / WT (g.)	b	B	C	D	E	F
1N895	50	40	677	21	34	61	131	123	393
1N896	63	50	1.143	26	38	75	165	151	460

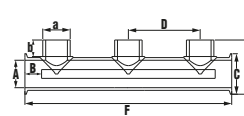

841

Colector distribuidor Net. Syst. /Net. Syst.
Manifold Net. Syst./ Net. Syst.

CÓDIGO / CODE	∅ A-a	DN	PESO / WT (g.)	b	B	C	D	E	F
1N897	50	40	645	21	34	61	131	86	393
1N898	63	50	1.090	26	38	94	165	111	460

**Enlaces
3 piezas**

26/54

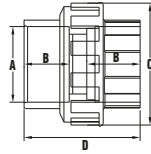

Enlace 3 piezas encolar
Union, plain socket-plain socket
Union 3 pièces, femelle/femelle à coller

CÓDIGO / CODE	CÓDIGO / CODE	Ø A	DN	PESO / WT (g.)	B	C	D
01079	-	20	15	35	16	41	46
01080	-	25	20	63	19	51	53
01081	-	32	25	85	22	62	58
01082	-	40	32	159	26	74	70
01163	01455	50-40	32	190	31	80	76
01083	01456	50	40	181	31	80	82
01166	01457	63-50	40	318	38	98	93
01084	01458	63	50	317	38	98	98
01085	-	75	65	620	44	121	109
01086	-	90	80	800	51	139	126
01087	-	110	100	1.211	61	163	146

81

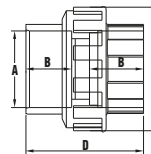

Enlace 3 p. encolar "BS"
Union, plain socket-plain socket BS
Union 3 pièces femelle/femelle à coller BS

CÓDIGO / CODE	Ø A	DN	PESO / WT (g.)	B	C	D
01150	1/2"	15	35	16	41	46
01151	3/4"	20	63	19	51	53
01152	1"	25	85	22	58	58
01153	1 1/4"	32	159	26	62	70
01154	1 1/2"	40	181	31	80	82
01155	2"	50	317	38	98	98
01085	2 1/2"	65	620	44	121	109

918

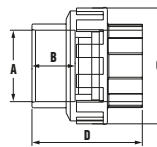

Enlace 3 p. encolar ANSI
Union, plain socket-plain socket ANSI
Union 3 pièces femelle/femelle à coller ANSI

CÓDIGO / CODE	Ø A	DN	PESO / WT (g.)	B	C	D
01865	1 1/2"	40	181	32	80	84
01866	2"	65	317	39	98	100

919

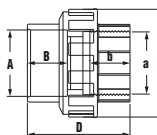

Enlace 3 p. mixto NPT/ANSI
Union, female thread NPT socket plain ANSI
Union 3 pièces mixte NPT/ANSI

CÓDIGO / CODE	Ø A	DN	PESO / WT (g.)	B	b	C	D
02434	1 1/2"-1 1/2"	40	210	32	32	80	84
02435	2"-2"	65	361	39	39	98	100

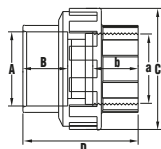

Enlace 3 piezas mixto
Union, plain socket-female threaded
Union 3 pièces mixte

27/55

CÓDIGO / CODE	CÓDIGO / CODE	Ø A-a	DN	PESO / WT (g.)	B	b	C	D
02028	-	1/2"-20	15	34	16	16	41	46
02029	-	3/4"-25	20	66	19	19	51	52
02030	-	1"-32	25	84	22	22	62	58
02031	-	1 1/4"-40	32	153	26	26	74	69
02032	02595	1 1/2"-50	40	210	31	31	80	85
02033	02596	2"-63	50	361	38	38	98	88
02034	-	2 1/2"-75	65	597	44	44	120	109
02035	-	3"-90	80	820	51	51	139	125
02036	-	4"-110	100	1.271	61	61	163	146

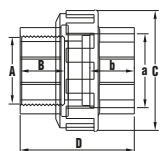

Enlace 3 p. mixto enc. salida R/H
Union, female thread socket plain
Union 3 pièces mixte taraudé/fem. à coller

28/56

CÓDIGO / CODE	CÓDIGO / CODE	Ø A-a	DN	PESO / WT (g.)	B	b	C	D
02114	02625	50-1 1/2"	40	820	51	51	139	125
02119	02626	63-1 1/2"	40	1.261	61	61	163	146

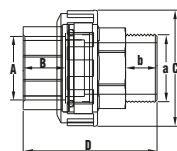

Enlace 3 p. mixto macho S-R/Hembra
Union, male socket-female threaded
Union 3 pièces mixte, mâle à coller/taraudée

30/58

CÓDIGO / CODE	CÓDIGO / CODE	Ø A-a	DN	PESO / WT (g.)	b	B	C	D
02515	02615	1 1/2"-1 1/2"	40	201	31	34	80	85
02519	02616	2"-1 1/2"	40	314	38	34	98	95

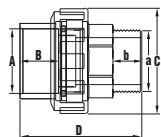

Enlace 3 p. mixto macho S/Encolar
Union, plain socket-male thread
Union 3 pièces mixte, femelle à coller fileté

29/57

CÓDIGO / CODE	CÓDIGO / CODE	Ø A-a	DN	PESO / WT (g.)	B	b	C	D
02074	-	3/4" - 25	20	58	19	16	51	64
02075	-	1"-32	25	98	22	19	62	72
02076	-	1 1/4"-40	32	174	26	21	74	89
02057	-	1 1/2"-40	32	236	26	21	80	93
02077	02805	1 1/2"-50	40	258	31	21	80	98
02060	02806	2"-50	40	421	31	26	99	115
02078	02807	2"-63	50	409	38	26	99	120
02079	-	2 1/2"-75	65	630	44	30	120	135

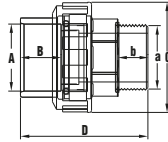

Enlace 3 p. mixto macho S/E con Junta tórica
Union, plain socket-male thread with o-ring
Union 3 pièces mixte, femelle à collar/fileté, avec joint

82/410

CÓDIGO / CODE	CÓDIGO / CODE	∅ A-a	DN	PESO / WT (g.)	B	b	C	D
02084	-	3/4" - 25	20	64	19	16	51	64
02085	-	1" - 32	25	101	22	19	62	72
02086	-	1 1/4" - 40	32	184	26	21	74	89
02087	-	1 1/2" - 40	32	244	26	21	80	93
02088	02815	1 1/2" - 50	40	233	31	21	80	98
02089	02816	2" - 50	40	434	31	26	99	115
02090	02817	2" - 63	50	420	38	26	99	120
02091	-	2 1/2" - 75	65	630	44	30	120	135

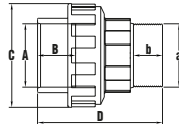

Enlace 3 p. mixto encolar salida r/m
Union, male thread socket plain
Union 3 pièces mixte filetéé/fem. à collar

920

CÓDIGO / CODE	∅ A	DN	PESO / WT (g.)	B	b	C	D
02358	32-1"	25	98	22	19	62	72
02360	50-1 1/2"	40	258	31	21	80	98
02361	63-2"	50	409	38	26	99	120

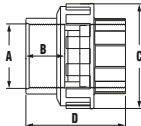

Enlace 3 piezas r/h
Union, female thread
Union 3 pièces taraudé

921

CÓDIGO / CODE	∅ A	DN	PESO / WT (g.)	B	C	D
02338	1"	25	89	22	62	58
02340	1 1/2"	40	251	31	80	84
02341	2"	50	368	38	98	100

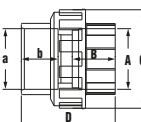

Enlace 3 piezas BS-Métrico
Union, plain socket-plain socket BS-metric
Union 3 pièces, femelle/femelle à collar BS-métrique

922

CÓDIGO / CODE	∅ A-a	DN	PESO / WT (g.)	B	b	C	D
01843	32-1"	25	85	22	22	62	58
01845	50-1 1/2"	40	210	32	31	80	84
01846	63-2"	50	361	39	38	98	100

Recambios

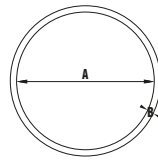

Junta tórica
O-ring
Joint

83

CÓDIGO / CODE	∅ mm	PESO / WT (g.)	AxB
98125	20	0,9	19x4
98164	25	1,1	26,57x3,53
98142	32	2,0	30x4
98143	40	2,9	42x4,50
98154	50	4,4	45x5,30
98155	63	5,2	58x5,30
98165	75	8,1	72,39x5,33
98102	90	12,5	91,44x5,34
98112	110	20,2	116,84x5,33

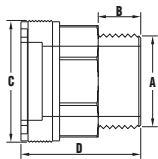

Racord S/Rosca macho enlace 3P
Union adaptor socket male threaded
Embout fileté, union 3 pièces

400/401

CÓDIGO / CODE	PESO / WT (g.)	CÓDIGO / CODE*	PESO / WT (g.)*	∅ A	B	C	D
02901	28	02921	34	3/4"	16	42	42
02902	42	02922	42	1"	19	48	51
02903	95	02923	95	1 1/4"	21	59	59
02904	124	02924	124	1 1/2"	21	66	63
02905	236	02925	236	2"	26	78	78
02906	410	02926	410	2 1/2"	30	89	86

*Con junta tórica / With o-ring

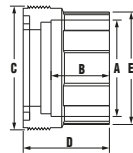

Racord encolar enlace 3 P.
Union adaptor solvent socket
Manchon à coller

84/399

CÓDIGO / CODE	∅ A	CÓDIGO / CODE BS	∅ A (BS)	PESO / WT (g.)	B	C	D	E
01925	20	01985	1/2"	12	16	33	26	28
01926	25	01986	3/4"	24	19	42	29	36
01927	32	01987	1"	30	22	48	32	42
01928	40	01988	1 1/4"	61	26	59	41	52
01929	50	01989	1 1/2"	89	31	66	46	59
01930	63	01990	2"	123	38	78	56	73
01931	75	01931	2 1/2"	225	44	89	61	85
01932	90	-	-	404	51	122	69	113
01933	110	-	-	602	61	145	79	134

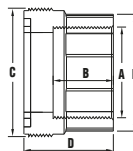

Racord R/H enlace 3 P.
Threaded union adaptor
Manchon taraudé

438

CÓDIGO / CODE	∅ A	PESO / WT (g.)	B	C	D	E
02934	1/2"	13	16	33	26	28
02935	3/4"	24	19	42	29	36
02936	1"	32	22	48	32	42
02937	1 1/4"	65	26	59	41	52
02938	1 1/2"	92	31	66	46	59
02939	2"	131	38	78	56	73
02940	2 1/2"	230	44	89	61	85
02941	3"	420	48	122	69	113
02942	4"	625	55	145	79	134

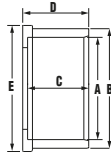

402/403

Manguito s/enc enlace 3P
Union coupling solvent socket outlet
Manchon à coller

CÓDIGO / CODE	Ø A	CÓDIGO / CODE BS	Ø A (BS)	PESO / WT (g.)	B	C	D	E
01905	20	01974	1/2"	8	27	16	19	30
01906	25	01975	3/4"	16	35	19	22	39
01907	32	01967	1"	21	41	22	26	45
01908	40	01968	1 1/4"	43	50	26	35	63
01914	50-40	-	-	43	50	26	35	63
01909	50	01969	1 1/2"	52	63	31	44	63
01915	63-50	-	-	52	63	31	44	63
01910	63	01970	2"	75	76	38	41	78
01911	75	01971	2 1/2"	135	87	44	48	85
01912	90	-	-	250	109	51	54	119
01913	110	-	-	423	131	61	68	142

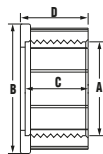

404

Manguito R/H enlace 3P
Union coupling female threaded
Manchon taraudé

CÓDIGO / CODE	Ø A	PESO / WT (g.)	B	C	D
02914	50-1 1/2"	60	63	31	44
02931	63-1 1/2"	92	76	31	41

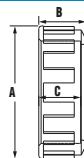

405

Tuerca enlace 3P
Union nut female thread
Écrou taraudé

CÓDIGO / CODE	d	PESO / WT (g.)	A	B	C
01913	20	13	41	22	16
01916	25	22	51	25	18
01917	32	39	62	27	20
01918	40	57	74	29	22
01919	50	73	80	33	26
01920	63	117	98	38	28
01921	74	255	121	43	34
01922	90	291	142	52	42
01923	110	416	166	60	48

Bridas y portabridas

65

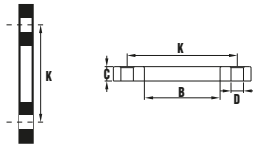

Brida plana PVC
Plain flange PVC-U
Bride plate PVC-U

CÓDIGO / CODE	Ø TUBO / PIPE	PESO / WT (g.)	B	K	C	D
10025	50	248	62	110	17	4x18
10026	63	311	78	125	18	4x18
10027	75	406	92	145	19	4x18
10028	90	494	110	146-160	20	8x18
10029	110	614	133	178-190	21	8x18
10030	125	648	149	190	23	8x18
10038	140x125	947	149	210-216	23	8x18
10031	140	791	167	210-216	26	8x18
10032	160	1.073	190	235-241	28	8x22
10033	200	1.204	227	270	30	8x22
10142	200-PN10	1.684	235	292-298	34	8x22
10034	225	1.205	249	292-298	34	8x22
10128	250	2.790	285	350-356	34	12x22
10129	315	3.154	350	400-425	34	12x22
10037	400	4.278	439	515	50	16x26

78



ÚNICO
= mercado

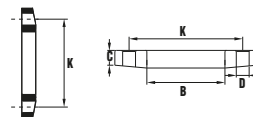

Brida plana seguridad PVC
Security plain flange
Bride plate de sûreté

CÓDIGO / CODE	Ø TUBO / PIPE	PESO / WT (g.)	B	C	K	D
10008	90	562	110	20	146-160	8x18
10009	110	672	133	22	178-190	8x18
10010	125	717	149	24	190	8x18
10011	140	885	167	26	210-216	8x18
10012	160	1.185	190	28	235-241	8x22
10013	200	1.302	227	30	270	8x22

66/67



PPFV

PA

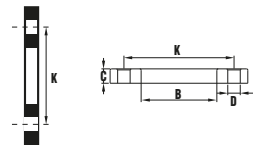

Brida maciza para PVC
Compact flange for PVC-U
Bride pleine PVC-U

CÓDIGO / CODE	PESO / WT (g.)	CÓDIGO / CODE*	PESO / WT (g.)*	Ø TUBO / PIPE	B	K	C	D
10015	250	10200	238	50	62	110	20	4x18
10016	296	10201	281	63	78	125	20	4x18
10017	403	10202	383	75	92	145	22	4x18
10018	508	10203	483	90	110	146-160	24	8x18
10019	652	10204	619	110	133	178-190	26	8x18
10020	652	10205	619	125	149	190	27	8x18
10070	953	10075	905	140x125	149	210-216	27	8x18
10021	756	10206	718	140	167	210-216	29	8x18
10022	985	10207	936	160	190	235-241	30	8x22
10023	1.032	10208	980	200	227	270	30	8x22
10119	1.323	10209	1.257	200-PN10	235	292-298	34	8x22
10024	1.050	10210	1.025	225	249	292-298	34	8x22
10214	2.192	10211	2.083	250	285	350-356	34	12x22
10215	2.478	10212	2.354	315	350	400-425	34	12x22

*De alta resistencia para PVC/High resistance to PVC-U

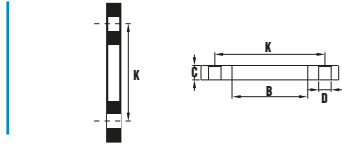

710/711



Brida maciza para PE
Compact flange for PE
Bride pleine for PE

CÓDIGO / CODE	PESO / WT (g.)	CÓDIGO / CODE*	PESO / WT (g.)*	Ø TUBO / PIPE	B	K	C	D
10476	250	10490	238	50	58	110	20	4x18
10477	296	10491	281	63	72	125	20	4x18
10478	403	10492	383	75	85	145	22	4x18
10479	508	10493	483	90	100	146-160	24	8x18
10480	652	10494	619	110	125	178-190	26	8x18
10481	652	10495	619	125	140	190	27	8x18
10482	953	10496	905	140x125	140	210-216	27	8x18
10483	756	10497	718	140	167	210-216	29	8x18
10484	985	10498	936	160	190	235-241	30	8x22
10485	1.032	10499	980	200	220	270	30	8x22
10486	1.323	10500	1.257	200-PN10	220	292-298	34	8x22
10487	1.050	10501	1.025	225	238	292-298	34	8x22
10488	2.192	10502	2.083	250	270	350-356	34	12x22
10489	2.478	10503	2.354	315	335	400-425	34	12x22

*De alta resistencia para PE/High resistance to PE

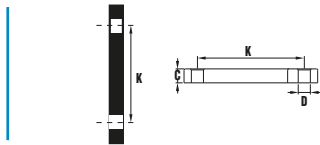

68

Brida tapón
Cap flange
Bride bouchon

CÓDIGO / CODE	Ø TUBO / PIPE	PESO / WT (g.)	K	C	D
10060	50	347	110	17	4x18
10061	63	435	125	18	4x18
10062	75	568	145	19	4x18
10063	90	692	146-160	20	8x18
10064	110	860	178-190	21	8x18
10065	125	907	190	23	8x18
10066	140	1.107	210-216	26	8x18
10067	160	1.502	235-241	28	8x22
10068	200	1.686	270	30	8x22
10217	200 PN10	1.687	292-298	34	8x22
10069	225	1.687	292-298	34	8x22
10071	250	3.906	350-362	34	12x22
10072	315	4.416	400-425	34	12x22

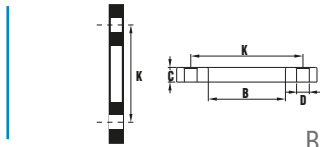

69

Brida plana acero zincado para portabrida PVC
Galvanized steel plain flange for PVC adaptor
Bride plate de sûreté en acier galvanisé pour porte bride PVC

CÓDIGO / CODE	Ø TUBO / PIPE	PESO / WT (g.)	B	K	C	D
10505	50	1.640	63	125	12	4x18
10504	63	1.640	78	125	12	4x18
10506	63	2.026	78	145	12	4x18
10507	75	1.925	92	145	13	4x18
10508	90	1.908	110	160	13	8x18
10509	110	2.191	132	170	13	8x18
10510	125	3.070	149	210	13	8x18
10511	140	2.356	167	210	13	8x18
10512	160	3.150	190	240	13	8x22
10513	200	5.228	235	295	15	8x22
10516	250	6.084	282	350	15	12x22
10517	315	6.540	348	400	15	12x22
10518	400	8.300	439	515	18	16x26

K= distancia entre tornillos (mm)/Distance between bolts (mm)

412

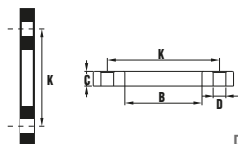

Brida plana acero zincado para portabrida PE
Galvanized steel security plain flange for PE adaptor
Bride plate de sûreté en acier galvanisé pour porte bride PE

CÓDIGO / CODE	Ø TUBO / PIPE	PESO / WT (g.)	B	K	C	D
10547	63	2.330	72	145	12	4x18
10548	75	2.214	85	145	13	4x18
10549	90	2.194	100	160	13	8x18
10550	110	2.520	125	170	13	8x18
10551	125	3.531	140	210	13	8x18
10552	140	2.709	152	210	13	8x18
10553	160	3.623	172	240	13	8x22
10554	200	6.012	220	295	15	8x22
10555	225	6.997	238	295	15	8x22
10556	250	7.521	270	350	15	12x22
10557	315	9.545	335	400	15	12x22

411

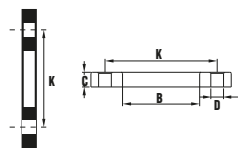

Brida plana recubierta de PP con alma de acero
Galvanized steel plain flange covered by PP
Bride plate de sûreté en acier galvanisé

CÓDIGO / CODE	Ø TUBO / PIPE	PESO / WT (g.)	B	K	C	D
10526	63	1.525	78	125	18	4x18
10527	75	2.002	92	145	19	4x18
10528	90	1.984	110	160	20	4x18
10529	110	2.279	132	170	21	8x18
10530	125	3.193	149	210	23	8x18
10531	140	2.450	167	210	26	8x18
10532	160	3.276	190	240	28	8x22
10533	200	5.820	235	295	34	8x22
10534	225	5.437	252	295	34	8x22
10535	250	6.327	282	350	34	12x22
10536	315	6.802	348	400	34	12x22

430

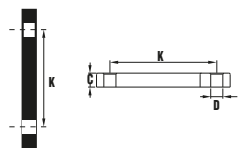

Brida ciega de acero zincado
Galvanized steel cap flange
Bride bouchon en acier galvanisé

CÓDIGO / CODE	Ø TUBO / PIPE	PESO / WT (g.)	K	C	D
10566	63	2.900	125	12	4x18
10567	75	3.200	145	13	4x18
10568	90	3.600	160	13	4x18
10569	110	4.000	170	13	8x18
10570	125	6.600	210	13	8x18
10571	140	6.300	210	13	8x18
10572	160	8.500	240	13	8x22
10573	200	14.100	295	15	8x22
10574	225	13.500	295	15	8x22
10575	250	17.200	350	15	12x22
10576	315	22.500	400	15	12x22

K= distancia entre tornillos (mm)/Distance between bolts (mm)

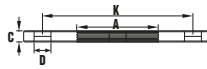

431

Brida roscada de acero galvanizado
Galvanized steel threaded flange
Bride acier en galvanisé, taraudée

CÓDIGO / CODE	Ø A	PESO / WT (g.)	K	C	D
10586	2"	2.010	125	12	4x18
10587	2 1/2"	2.290	145	13	4x18
10588	3"	2.425	160	13	4x18
10589	4"	2.875	170	13	8x18

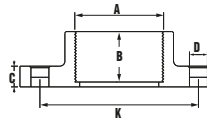

71

Brida compacta, S/H reforzada
Flange compact female threaded, reinforced
Bride compacte taraudée, renforcée

CÓDIGO / CODE	Ø A	PESO / WT (g.)	B	K	C	D
10055	1 1/2"	384	29	110	18	4x18
10056	2"	445	30	125	18	4x18
10057	2 1/2"	612	30	145	19	4x18
10058	3"	789	35	146-160	21	8x18
10059	4"	1.045	39	178-190	23	8x18

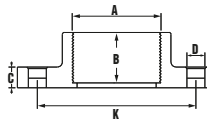

70

Brida compacta, PVC salida encolar
Flange compact, solvent socket
Bride compacte, à coller

CÓDIGO / CODE	Ø A	PESO / WT (g.)	B	K	C	D
10045	50	340	31	110	18	4x18
10046	63	408	38	125	18	4x18
10047	75	544	45	145	19	4x18
10048	90	716	51	146-160	21	8x18
10049	110	977	61	178-190	23	8x18
10050	125	1.160	69	190	24	8x18
10051	140	1.467	76	210-216	27	8x18
10052	160	2.050	86	235-241	28	8x22

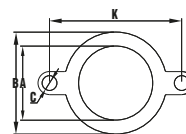

73

Junta plana
Flat gasket
Joint plat

CÓDIGO / CODE	Ø A	PESO / WT (g.)	B	K	C	e (espesor) mm
10159	50	9	71	110	18	3
10160	63	11	88	125	18	5
10161	75	15	104	145	18	3
10121	90	21	123	160	18	3,4
10122	110	34	146	180	18	4,2
10123	125	39	163	190	18	4,2
10124	140	51	183	210	18	4,3
10125	160	64	207	240	22	4,3
10126	200	109	240	270/295	24	5,2
10162	250	236	318	350	24	7,7
10163	315	265	368	400	24	7,7



73/1 / 712

VITON

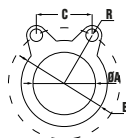

Junta plana caucho
Rubber flat gasket
Joint plat caoutchouc

CÓDIGO / CODE	CÓDIGO / CODE	∅ A	PESO / WT (g.)	B	K	C	e (espesor) mm
10238	-	32	5	70	70	47	3
10239	-	40	6	82	77	53	3
10240	10223	50	9	96	87	61	3
10241	10224	63	12	96	93	65	3
10242	10225	75	17	121	93	71	3
10243	-	90	22	130	61	78	3
10237	10226	90-PN10	37	130	106	74	3
10244	10227	110	42	154	68	88	3
-	10228	125	56	183	81	107	3
10246	10229	140	56	183	81	107	3
10247	10230	160	72	208	91	118	3
10248	10231	200	130	223	79	125	4
10250	10232	225	126	263	79	146	3
10251	10233	250	161	316	91	176	4
10252	10234	315	177	425	102	203	4
10253	-	400	230	477	264	261	4



72/74

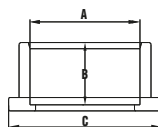

Portabrida plano
Plain adaptor
Porte bride plat

CÓDIGO / CODE	∅ A	PESO / WT (g.)	CÓDIGO BS	∅ A (BS)	PESO / WT (g.) BS	B	C
10130	50	62	10400	1 1/2"	64	31	73
10131	63	107	10401	2"	112	38	90
10132	75	185	10402	2 1/2"	185	44	106
10133	90	275	10403	3"	275	51	125
10134	110	497	10404	4"	468	61	150
10135	125	597	-	-	-	69	168
10136	140	830	10405	5"	597	76	188
10137	160	1.180	10406	6"	1.120	86	213
10138	200	1.650	-	-	-	100	247
10143	200-PN10	1.890	10407	8"	1.785	106	261
10139	225	1.765	-	-	-	127	274
10140	250	2.700	-	-	-	131	328
10141	315	4.815	-	-	-	164	378
10144	400	8.705	-	-	-	220	485



75/76

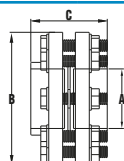

Enlace brida plana
Plain flange set
Union bride plate

CÓDIGO / CODE	∅ A	PESO / WT (g.)	CÓDIGO / CODE BS	∅ A (BS)	PESO / WT (g.) BS	B	C
10147	50	1.395	10755	1 1/2"	1.367	150	71
10148	63	1.726	10756	2"	1.691	165	87
10149	75	2.046	10757	2 1/2"	2.005	185	97
10150	90	3.287	10758	3"	3.221	200	115
10151	110	4.104	10759	4"	3.899	220	136
10152	125	4.455	-	-	-	230	152
10153	140	5.214	10760	5"	5.110	250	166
10154	160	6.298	10761	6"	5.983	285	186
10155	200	9.769	-	-	-	315	229
10117	200-PN10	11.841	10762	8"	11.630	340	242
10156	225	10.953	-	-	-	340	255
10157	250	14.319	-	-	-	400	284
10158	315	21.243	-	-	-	450	351

K= distancia entre tornillos (mm)/Distance between bolts (mm)

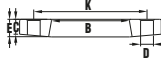

77

Brida cónica seguridad
Conical security flange
Bride conique de sûreté

CÓDIGO / CODE	Ø TUBO / PIPE	PESO / WT. (g.)	B	C	E	K	D
10091	90	530	110	20	26	160	8x18
10092	110	640	133	22	31	180	8x18
10093	125	673	149	24	33	190	8x18
10094	140	821	167	26	35	210	8x18
10095	160	1.172	190	28	37	240	8x22
10096	200	1.253	227	30	40	270	8x22

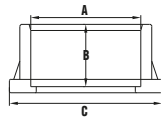

79

Portabrida cónico seguridad
Security conical adaptor
Porte bride conique de sûreté

CÓDIGO / CODE	Ø A	PESO / WT. (g.)	B	C
10099	90	370	51	125
10101	110	482	61	150
10102	125	647	69	168
10103	140	915	76	188
10104	160	1.116	86	213
10105	200	1.675	100	247

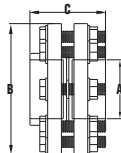

80

Enlace brida cónico seguridad
Security conical flange branch
Union bride conique de sûreté

CÓDIGO / CODE	Ø A	PESO / WT. (g.)	B	C
10106	90	3.390	200	115
10107	110	4.240	220	136
10108	125	4.600	230	152
10109	140	5.370	250	166
10110	160	6.490	284	186
10111	200	10.060	315	229

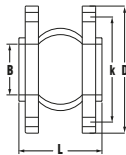

914

Manguito antivibratorio
Anti-vibration sleeve
Manchon antivibratoire

CÓDIGO / CODE	A	DN	PN	PESO / WT. (g.)	B	L	D	k	N
10600	63	50	10/16	3.000	52	105	165	125	4
10601	75	65	10/16	5.500	68	115	185	145	4
10602	90	80	10/16	6.500	76	130	200	160	8
10603	110	100	10/16	7.500	103	135	220	180	8
10604	140	125	10/16	10.500	128	165	250	210	8
10605	160	150	10/16	13.000	152	180	285	240	8
10606	200	200	10	18.000	194	210	340	295	8
10616	200	200	16	18.500	194	210	340	295	12
10607	250	250	10	26.600	250	240	395	350	12
10617	250	250	16	28.000	250	240	405	355	12
10608	315	300	10	37.000	300	255	445	400	12
10618	315	300	16	39.500	300	255	460	410	12

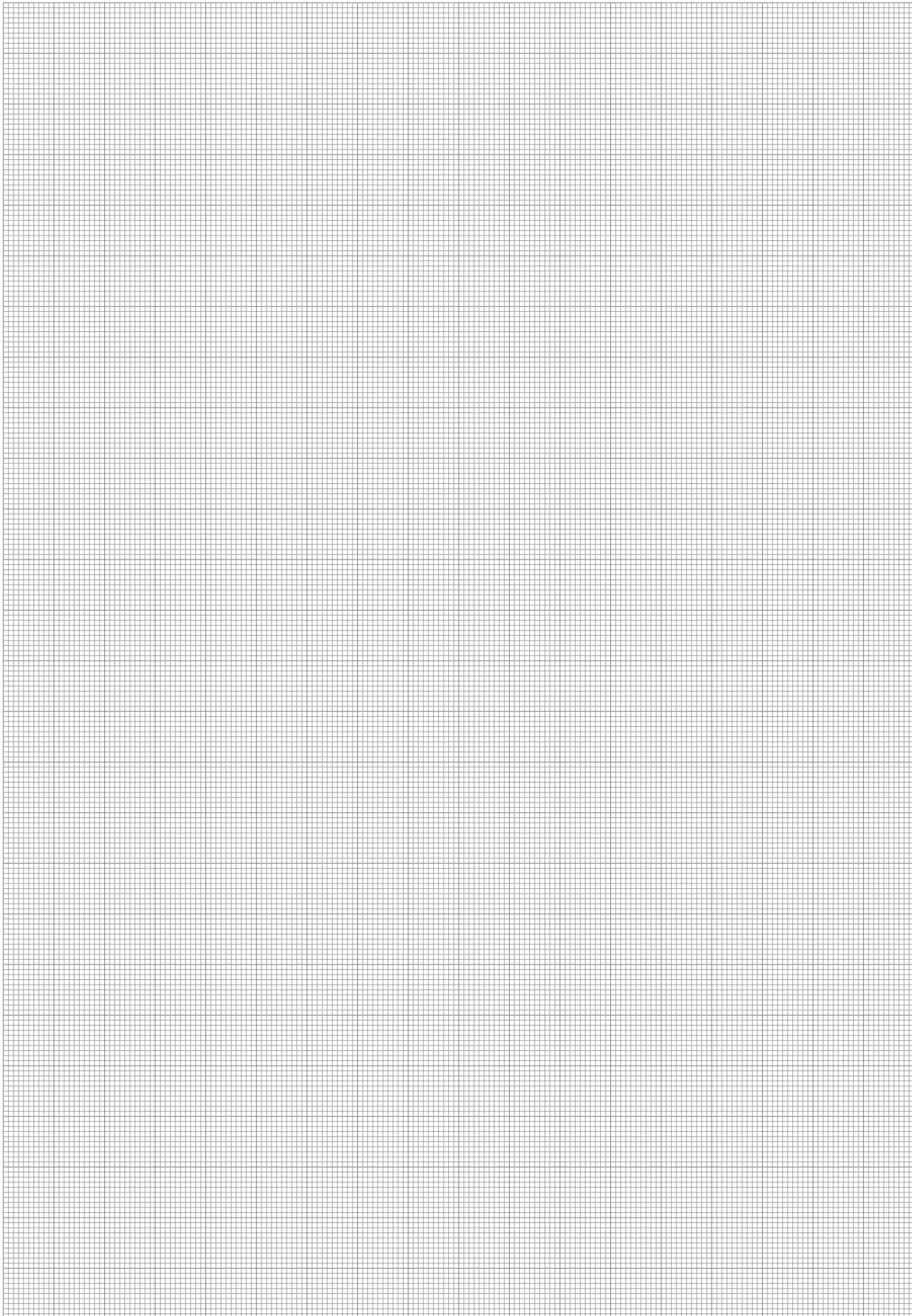

HIDROTEN, S.A.

Polig. I. Plá Vallonga, c/ Agua, 28

03006 ALICANTE (España)

Telf. 965 11 42 82

Fax: 965 11 48 62

I INTERNACIONALES I

Telf. +34 965 11 42 82

Fax: +34 965 11 48 62

Telf. Información Técnica:

+34 966 105 888

www.hidroten.es

I E-mails I

comercial@hidroten.es

export@hidroten.es

administracion@hidroten.es

tecnico@hidroten.es

publicidad@hidroten.es

prescripcion@hidroten.es



¡Síguenos en redes sociales!

